

1982
Precision Sound Level Meter
and Analyzer
User and Service Manual



IET LABS, INC.
formerly manufacturer by
GenRad

534 Main Street, Westbury, NY 11590 www.ietlabs.com
TEL: (516) 334-5959 • (800) 899-8438 • FAX: (516) 334-5988

Contents

This instrument is capable of making sound-level measurements required under Part 1910.95 "Occupational Noise Exposure," (Dept of Labor) of the Code of Federal Regulations, Chap. XVII of Title 29 (36 F.R. 7006).

Contents

1. GENERAL	1
2. OPERATING INSTRUCTIONS	2
3. MEASUREMENT PROCEDURE	3
4. FILTERS AND FREQUENCY WEIGHTING	4
5. HOLD AND RANGE FUNCTIONS	5
6. DETECTOR SYSTEM	6
7. METERS AND BATTERIES	7
8. MAX HOLD DETECTOR	8
9. FREQUENCY RESPONSE	9
10. AIR CIRCUIT	10
11. POWER SUPPLY	11
12. SERVICE AND MAINTENANCE	12
13. SPECIFICATIONS	13
14. PERFORMANCE TESTS	14
15. DIMENSIONS	15
16. WEIGHT	16
17. ACCESSORIES	17
18. WARRANTY	18
19. ORDERING INFORMATION	19
20. CONTACT INFORMATION	20

GR 1982 Precision Sound-Level Meter and Analyzer

Form 1982-0100-G



IET LABS, INC.
534 Main Street
Westbury, NY 11590

www.ietlabs.com 516-334-5959 Fax: 516-334-5988

Specifications

Description	Catalog Number
Precision Sound-Level Meter and Analyzer (supplied with 1/2-inch flat random incidence response electret condenser microphone) and accessories.	1982-9700
Precision Sound-Level Meter and Analyzer (supplied with 1/2-inch flat perpendicular incidence response electret condenser microphone) and accessories.	1982-9710

Standards:

Meets the following (use GR 1986, 1987, 1562-A or 1567 Sound-Level Calibrator):

ANSI standard specifications for sound-level meters S1.4-1971, Type 1 (Precision)

IEC Sound-Level Meter Standard 651, Type 1.

ANSI standard specification for Octave, Half-octave, and Third-octave Band Filter Sets S1.11-1966, Type 0, Class II

IEC Recommendation Publication 225-1966, Octave, Half-octave, and Third-octave Band Filters for the Analysis of Sounds and Vibrations

Level Range:

30-130 dB re $20 \mu\text{Pa}^\dagger$ rms (140-dB PEAK). May be extended to 140-dB rms (150-dB PEAK) using 10-dB microphone attenuator (1962-3200) supplied. Minimum Measurable Levels, A Weighting -34 dB.*

Frequency Response: A, B, and C weighting; 10 octave-band filters ranging in center frequency from 31.5 Hz to 16 kHz; a FLAT response from 10 Hz to 20 kHz (-3 dB nominal at frequency limits).

Detector Characteristics: DETECTOR RESPONSE[◆]: Fast, Slow, Impulse (per IEC 651), and Absolute Peak (<50 μs rise time), switch selected. Precise rms detection for signals with crest factors as high as 20 dB at 120 dB** (10 dB at 130 dB). OVERLOAD: Signal peaks monitored at two critical points to provide positive panel lamp warning of overload.

Display: ANALOG: Meter with 3-inch scale marked in 1-dB increments, four ranges: 30-80 dB, 50-100 dB, 70-120 dB, 90-140 dB. DIGITAL: 4-digit LED display with 0.1-dB resolution. Direct reading on all ranges. DIGITAL DISPLAY MODES: OFF, for minimum battery drain; CONTINUOUS, like meter except present reading can be "captured" by pushbutton; MAXIMUM, automatically holds highest level in measurement interval, until reset by pushbutton.

[†]In the international system of units (SI) the unit of pressure is the pascal (Pa). $1 \text{ Pa} = 1 \text{ N/m}^2 = 10 \text{ dynes/cm}^2 = 10^{-2} \text{ mbar}$. REF: "The International System of Units (SI)". U.S. Dept. of Commerce, National Bureau of Standards, NBS Special Publication 330 SD Cat. No. C13. 10.330/2, U.S. GPO, Washington, D.C. 20402.

*Noise floor at least 5 dB below minimum measurable levels. Levels apply with -45 dB re 1 V/N/m^2 microphone with digital display on.

◆ U.S. Patent No. 3681618

**10 dB higher when 10-dB microphone attenuator supplied is used.

Microphone: TYPE: 1/2-inch Electret-Condenser Microphone with flat random (-9700) or perpendicular (-9710) incidence response. MOUNTING: Mounted with detachable preamplifier (1981-4000) that plugs into nose of instrument, or can be remoted with 10-ft. cable (1933-0220) supplied; also with 20-ft. cable (1933-9614) or 60-ft. cable (1933-9601) available. INPUT IMPEDANCE: Approximately $2\text{ G}\Omega // <3\text{ pF}$.

Outputs: AC OUTPUT: 0.4 V rms nominal behind $5\text{ k}\Omega$ corresponding to full scale deflection, any load permissible. DC OUTPUT: 3 V behind $30\text{ k}\Omega$ corresponding to full-scale meter deflection. Output is linear in dB at 60 mV/dB over 70-dB range (50-dB display range plus 20 dB crest-factor allowance). Any load permissible.

Calibration: FACTORY: Fully tested and calibrated to all specifications; acoustical response and sensitivity are measured in a free field by comparison with a Western Electric Type 640AA Laboratory Standard Microphone whose calibration is traceable to the U.S. National Bureau of Standards. Reference Level is 94 dB at 1 kHz on 50 to 100 dB range.

FIELD: GR 1986, 1987, 1562-A or 1567 Sound-level Calibrators are available for making an overall pressure calibration.

Environmental: TEMPERATURE: -10° to 50°C operating within 0.5 dB, -40°C to $+60^{\circ}\text{C}$ storage with batteries removed, $+15^{\circ}$ to $+50^{\circ}\text{C}$ during battery charging. Humidity: 0-90% RH operating within 0.5 dB. MAGNETIC FIELD: 1 oersted (80 A/m 60-Hz field causes 50-dB C-weighted indication (negligible A-weighted indication) when meter is oriented for maximum sensitivity to field. The equivalent A-weighted response to a 1-oersted 400-Hz field is approximately 55 dBA with the meter oriented for maximum sensitivity to the field. VIBRATION: When the sound-level meter, with attached microphone, is vibrated at an acceleration of 0.1 g at frequencies of 63, 250, and 1000 Hz, levels resulting from the vibration are less than the background noise levels which were as high as 59 dB. A similar test with the microphone replaced with an equivalent impedance yields no meter indication.

Power: Removable battery pack containing 3 AA-size nickel-cadmium rechargeable cells with charger interlock. Battery life between charges 3 to 4½ hours depending on digital display usage. Battery charger supplied, operates on 115/220 volts AC, 50-60 Hz; full recharge accomplished in about 4 hours. Three AA-size alkaline cells (not rechargeable) may be used in place of the battery pack.

Mechanical:

1982-9700, -9710 dimensions:

WIDTH		LENGTH		DEPTH		NET WT.		SHPG. WT.	
in.	mm.	in.	mm.	in.	mm.	lb.	kg.	lb.	kg.
3.9	99	16.75	425	2.32	59	3	1.36	5.4	2.43

Accessories Supplied:

1982-9700, -9710

Battery Pack Assembly	1981-2050
Battery Charger	1981-0425
Microphone, ½-in., electret-condenser, random-response (1982-9700 model)	1962-3300*
Microphone, ½-in., electret condenser, perpendicular-response (1982-9710 model)	1962-3310*
Microphone Extension Cable, 10-foot	1933-0220
10-dB Microphone Attenuator	1962-3210
Calibration Screwdriver	7985-1000
Wrist Strap	1981-0410
Sub-miniature Phone Plug (2)	4270-1110
Instruction Manual	1982-0100
Microphone Windscreen	1560-7551
Charging Tag	5301-1561
Envelope (Microphone Curve)	1560-0157
Pouch, Carrying	1982-0460
Label	1981-0405

*U.S. Patent Number 4,070,741.

Accessories Available:

Carrying Case (includes space for 1982 SLM, 1562 or 1567 calibrator, microphone extension cable, tripod and misc accessories)	1982-9610 [†]
Carrying Case (includes space for 1982 SLM, 1987 calibrator, microphone extension cable, tripod and misc accessories)	1982-9620 [†]
Carrying Case (includes space for 1982 SLM, 1986 calibrator, microphone extension cable, tripod and misc accessories)	1982-9630 [†]
Calibrator Type 1562-A, 5 frequencies, single level	1562-9701
Calibrator Type 1987, single frequency, 2 levels	1987-9700
Calibrator Type 1986, 6 frequencies, 5 levels, 3 tone-burst signals	1986-9700
Battery-Pack Assembly	1981-9602
Microphone Extension Cable, 60-ft	1933-9601
Microphone Extension Cable, 20-ft	1933-9614
Tripod (mounts either 1982 SLM or preamplifier)	1560-9590
Vibration Integrator System	1933-9610
Audiometer Calibration Accessory Kit	1560-9619
Recorder, dc, strip chart	1985-9700
Dummy Microphone, 35 pF, BNC female input, capacitance-matched to 1962-9601/-9602 microphones	1560-9609
Dummy Microphone, 22 pF, BNC female input, capacitance-matched to 1962-9610/-9611 microphones	1962-9620
Windscreen (package of 4)	1560-9522
Adaptor cables for connection to outputs, all 3 feet (0.9m) long:	
Miniature phone plug to GR 274 double banana plug	1560-9677
Miniature phone plug to BNC male	1560-9679
Miniature phone plug to standard (0.250-inch diameter) phone plug	1560-9678
Miniature phone plug to standard phone jack	1560-9680

[†]Each component listed in parentheses must be ordered individually.

Condensed Operating Instructions

BATTERY CHECK

- a. Slide the Power switch to the BAT position and hold it there briefly. Verify that the meter pointer indicates in the BAT ok area and that the digital display indicates 888.8. If it does not, charge or replace battery (Para. 1.6.1).
- b. Perform the battery check at least once during every half hour of use.
- c. Warm-up period not required.

CALIBRATION (Use GR 1562-A or 1567 Sound-level Calibrators)

- a. Verify that the calibrator battery checks OK.
- b. Slide the 1982 Power switch to ON and the DIGITAL DISPLAY switch to CONT. Set the OCTAVE FILTER switch to WTG, the WEIGHTING switch to A, and the DETECTOR switch to SLOW. Select the 70 to 120 dB RANGE.
- c. Turn the calibrator on and, if using the 1562, set the calibrating frequency to 1000 Hz.
- d. Place the calibrator, with 1/2-inch coupler/adaptor installed, over the microphone of the sound-level meter (SLM).
- e. Observe that both the SLM meter pointer and the digital display indicate 114 ±0.5 dB. If the indication is outside this range, adjust the CAL control. Refer to calibrator instruction manual for altitude and pressure corrections to calibrator, if necessary.
- f. To ensure optimum accuracy, perform the GR 1982 calibration within its actual operating environment, before and after each series of measurements.

OPERATION

- a. Select the desired weighting by sliding the WEIGHTING switch to A, B, C, or FLAT. The OCTAVE FILTER switch must be in the WTG position.
- b. Select desired detector characteristic by sliding the DETECTOR switch to FAST, IMP, PEAK, or SLOW. The detector can be reset in either the IMP or PEAK modes by depressing the CAPTURE button momentarily.
- c. Adjust the dB RANGE switch for an on-scale meter indication and read the meter or digital display. If the OVERLOAD lamp is lit, adjust the dB RANGE switch to a higher range.

DIGITAL DISPLAY

- a. For a display that duplicates the meter indication, set the DIGITAL DISPLAY switch to CONT. The display will now track the meter indication.
- b. To capture a measurement, slide the DIGITAL DISPLAY switch to CONT and at the desired moment, press and hold the CAPTURE button. The digital display will be "frozen" as long as the CAPTURE button is held.
- c. To capture the maximum indication during a measurement period, slide the DIGITAL DISPLAY switch to MAX. Press the CAPTURE button and release it to begin the measurement period.

Condensed Operating Instructions (continued)

OPERATOR POSITION

Preferably, the operator should be the same distance from the sound source as the microphone. Hold the sound-level meter at arms-length. DO NOT stand between sound source and microphone; DO NOT place the hand within 12 cm (5 inches) of the microphone. For most accurate measurements, connect the microphone to the cable supplied, and remove both sound-level meter and observer from the sound field.

If the microphone is the "flat-random-incidence-response" type, the shortest path from the sound source should be along a 70° line to the microphone's axis. Grazing incidence (90°) gives practically the same results.

If the microphone is the "flat-perpendicular-incidence-response" type, the shortest path from the sound source should be along the 0° line to the microphone's axis.

For additional information refer to paragraph 1.7.

Handbook of Noise Measurement

This book, by Dr. A. P. G. Peterson and Ervin E. Gross, Jr., of the GenRad Engineering Staff covers thoroughly the subject of noise and vibration measurement. Copies are available from GenRad at \$12.95 each, postpaid in the United States and Canada.

GR P/N 5301-8111

Operation—Section 1

1.1 PURPOSE

The GR 1982 is a precision instrument that conforms to both the ANSI* and IEC† standards for Type 1 sound-level meters. This affords the greatest accuracy of reading and ease of operation. It contains all the features required to perform plant-noise surveys, to select sound-barrier materials and ear protectors, to locate the problem-noise sources, and to perform various vehicle and community-noise surveys. When the instrument is used properly, the type-1 accuracy ensures precise readings. The 50-dB linear scale and digital display offer even to the novice the confidence of accurate noise measurement indications.

1.2 DESCRIPTION

The GR 1982 is a precision sound-level meter which incorporates octave-band filters from 31.5 Hz to 16 kHz, A, B, C and Flat weighting networks, as well as FAST SLOW, IMPACT and IMPULSE detector response. The sound-pressure level is displayed on a 50-dB linear scale. The instrument utilizes a 4-digit display which follows the analog meter indication with a 0.1-dB resolution. A reading can be captured on the digital display at the precise instant required while the analog meter continues to track the incoming noise level. The digital display can be used in the continuous mode or it can be operated to capture and hold the maximum level encountered. This mode is extremely useful when measuring sounds of short duration or vehicle "passby" sounds. In the maximum mode the digital display will be updated by the highest sound level. The display can be reset by the press of a button. In the peak (impact) or impulse modes the peak detector can be reset by the press of a button. This allows other readings to be taken without waiting for the peak detector to decay.

The true-RMS detector allows the presentation on a 50-dB scale with at least 70 dB dynamic range.

The single attenuator is switched to select four ranges: 30-80, 50-100, 70-120, and 90-140 dB. When the 10-dB microphone attenuator is used, the range is extended to 150 dB in the peak and impulse modes.

The microphone and preamplifier are removable and can be used with cables up to 60 feet long without additional equipment. Outputs are provided to drive an ac or dc recorder.

1.3 CONTROLS, INDICATORS, AND CONNECTORS

Figure 1-1 and Table 1-1 illustrate and describe the GR 1982 controls, indicators, and connectors.

*American National Standards Institute, Inc., 1430 Broadway, New York, N.Y. 10018.

†International Electrotechnical Commission, 1 Rue de Varembe', Geneva, Switzerland.

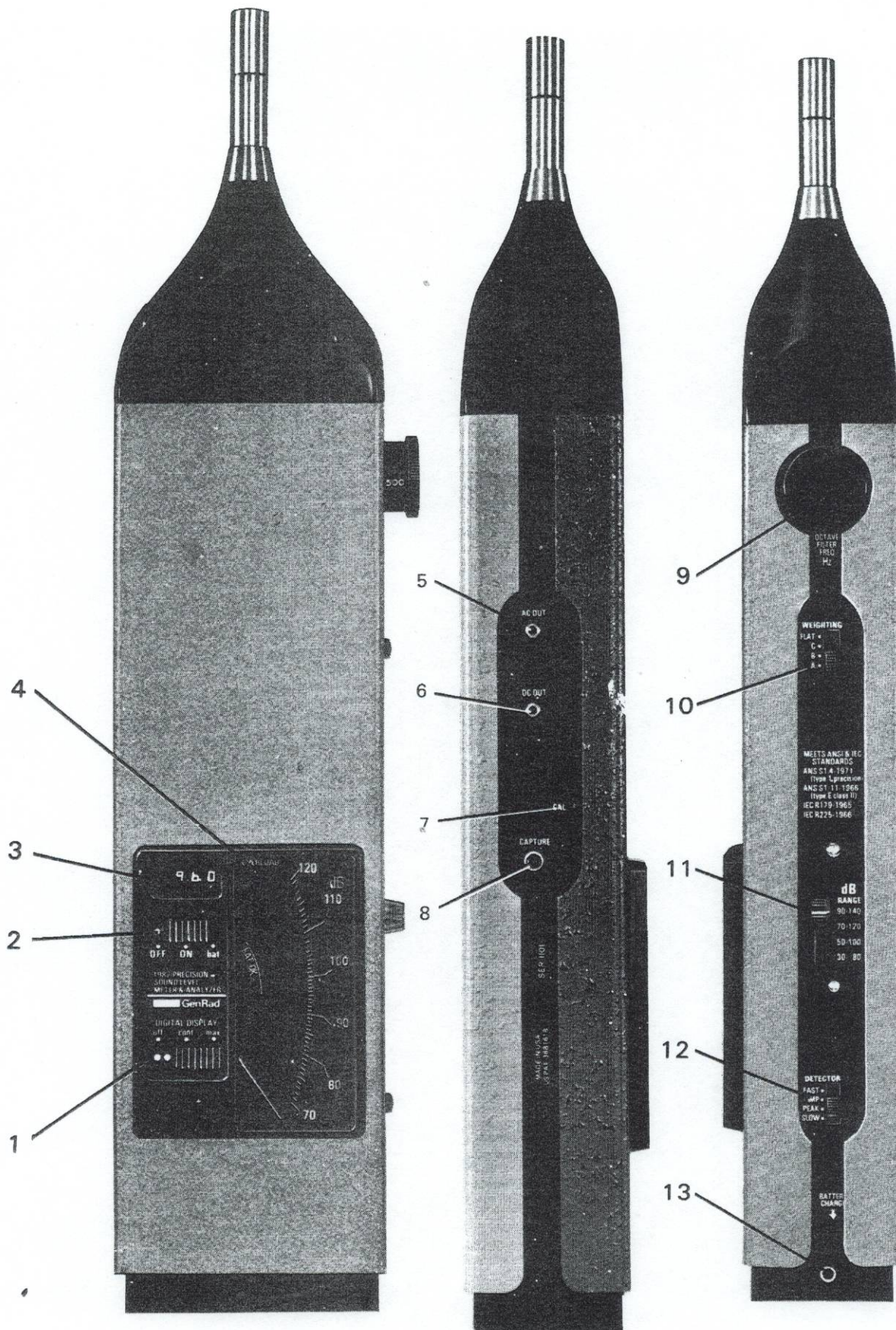

Figure 1-1. Controls, Indicators, and Connectors

1-2 OPERATION

Table 1-1
CONTROLS, INDICATORS, AND CONNECTORS

Fig. 1-1
Reference

Reference	Name	Description	Function
1	DIGITAL DISPLAY	3-Position Slide Switch; OFF, CONT, MAX	OFF inhibits digital display; CONT selects continuously updated digital display; MAX selects display of highest measurement since last release by item 8.
2	Power Switch	3-Position Slide Switch; OFF, ON, BAT.	OFF disconnects instrument from dc power supply; ON enables normal operation BAT causes meter to indicate battery condition.
3	Digital Display	4-digit readout with fixed decimal point after 3rd digit; red light-emitting diode type (LED)	Displays sound level as selected by item 1 in 0.1-dB increments. Display blanks at a point 5 dB below the bottom of range selected by item 11. Indicates 888.8 when item 2 is held in BAT position.
4	Meter	Analog meter with 3-inch scale. Displays 50 dB range and BAT OK mark at mid-range.	Continuously indicates sound level at microphone if level is within the selected range (item 11).
5	AC OUT	Subminiature phone jack	Connects AC output for external equipment such as AC recorder, oscilloscope and headphones. Output is 400 mVac at full scale in all measurement modes.
6	DC OUT	Subminiature phone jack	Connects DC output for external equipment such as dc recorder. Output is 3 Vdc at full scale in all measurement modes.
7	CAL	10-turn screwdriver — adjustment potentiometer	Provides overall calibration of sound level meter.
8	CAPTURE	Pushbutton; spring return	Depressing it locks digital display. Releasing it when item 1 is in MAX resets the display. Depressing and releasing it resets peak detector when item 12 is in PEAK or IMPULSE position.
9	OCTAVE FILTER FREQ Hz	Knob, 11-position rotary switch	Selects one of 10 octave-band center frequencies or WEIGHTING mode.

Table 1-1 (Con't)
CONTROLS, INDICATORS, AND CONNECTORS

Fig 1-1 Reference	Name	Description	Function
10	WEIGHTING	4-position slide switch	When item 9 is in WEIGHTING position, select A,B,C, or FLAT weighting.
11	dB RANGE	4-position slide switch	Selects one of four 50-dB ranges.
12	DETECTOR	4-position slide switch	Selects FAST, PEAK, IMPULSE or SLOW detector response.
13	BATTERY CHARGE	Miniature phone jack	Connects battery charger to rechargeable battery pack.
14	Preamplifier Retaining Screw	Straight slot screw	1 1/2 turns CCW releases preamplifier for removal.

1.4 SOUND, THE SOUND LEVEL METER

Sound pressure is air pressure that oscillates above and below atmospheric pressure at the instant a sound is generated. A sound can also be thought of as a particle of air that is displaced from its equilibrium position and bumps into surrounding particles. These surrounding particles are set in motion by the bumping and then in turn bump into adjacent particles. In this manner, sound is transmitted through the atmosphere. This displacement of the air is detected by the ear and subsequently converted into the sensation we call sound.

A sound-level meter (SLM) is an instrument that measures sound pressure. Basically, it contains a microphone, an amplifier, weighting networks or filters, and an indicator.

An "A-weighting" network, for example, alters the frequency response of the SLM so that it responds in a similar manner as does the human ear. Hearing Damage Risk Criteria are defined in terms of an A-weighted sound level and the duration of exposure to that level. Noise reduction or control consists primarily of barriers erected to shield an operator from a noise source, walls and ceilings treated to reduce reflected sound, or of ear protectors provided to workers. Since the effectiveness of these methods varies with the frequency, it is necessary to determine which frequency components comprise the offending noise. A detailed analysis of these components can be accomplished quickly by using a sound-level meter which contains octave-band filters.

The GR 1982 Precision Sound Level Meter and Analyzer contains the necessary weighting networks and octave-band filters required to perform the sound measurements and analyses mentioned above.

1.5 ACCESSORIES

Figure 1-2 illustrates the accessories that are supplied with the GR 1982-9700/-9710. Table 1-2 outlines these items.

Table 1-3 lists three 1982 carrying cases which are available to accommodate different sound-measurement systems that include the GR 1982. Each carrying case has a unique interior-compartment configuration designed for a specific calibrator, all of the accessories supplied with the 1982 and some accessories available via order. The 1982-9610 carrying case is intended for the use with the GR 1562 or 1567 calibrator, the 1982-9620 case for the GR 1987 calibrator and the 1982-9630 case for the GR 1986 calibrator.

1-4 OPERATION

Figure 1-3 shows a sample sound-measurement system that can be included in a 1982 carrying case. The particular carrying case shown in this figure is the 1982-9630, which has a specially shaped compartment for the 1986 calibrator. Refer to para 1.6.6 for an illustration of a measurement system packed in its carrying case.

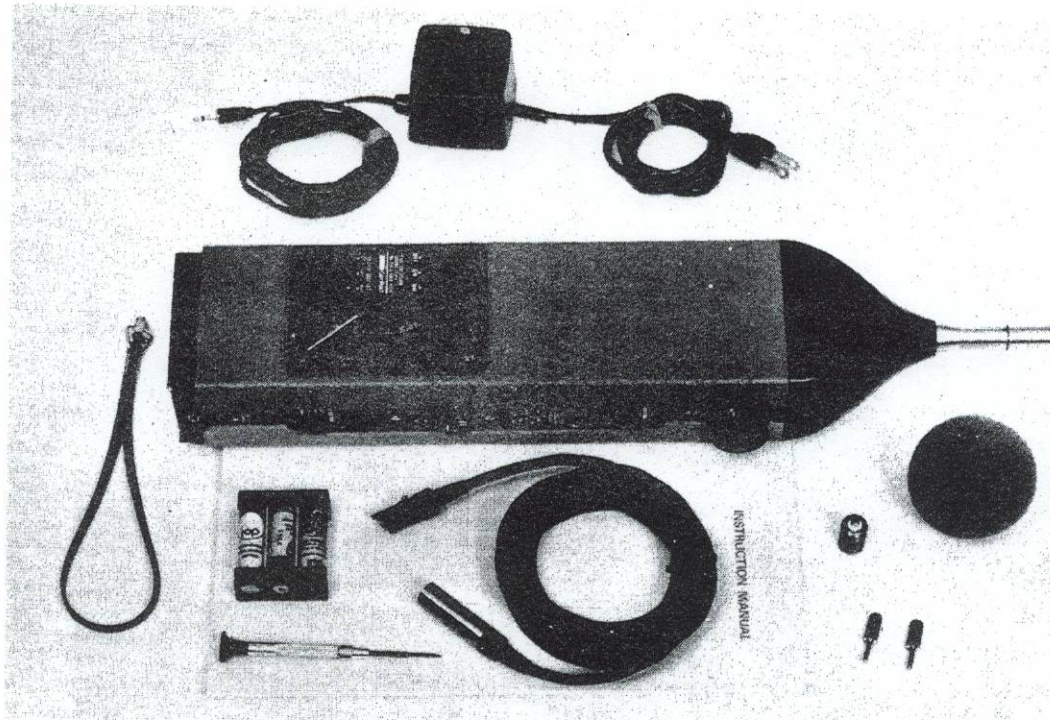

Figure 1-2. Supplied accessories with GR 1982-9700/-9710.

Table 1-2
SUPPLIED ACCESSORIES WITH GR 1982-9700/-9710

Quantity	Description (See Figure 1-2)	Part Number
1	Precision Sound-Level Meter, instrument only	1982-3000
1	*Microphone 1/2" diam, "random", with 9700; "perpendicular", with 9710	
1	Battery pack assembly	1981-2050
1	Battery charger	1981-0420
1	Wrist strap	1981-0410
1	Calibration screwdriver	7985-1000
2	Sub-miniature phone plug	4270-1110
1	Microphone extension cable, 10-foot	1933-0220
1	Instruction Manual	1982-0100
1	Microphone windscreen	1560-7551
1	Pouch, carrying (not shown)	1982-0460
1	Attenuator, 10 dB	1962-3210
1	Envelope (Mic Curve)	1560-0157
1	Charging Tag	5301-1561

*1/2-in. Random — 1962-3300;
1/2-in. Perpendicular — 1962-3310.

Table 1-3
AVAILABLE CARRYING CASES

Carrying Case Catalogue No.	Compatible Calibrator(s) *	Compatible Instruments And Accessories †
1982-9610	1562-9700 or 1567-9700	<i>Foam-Plastic Compartments For:</i> 1982 SLM, one microphone extension cable (1933-0220, -9601 or 9614), tripod and tilting swivel head (sleeve detached), 1982 battery pack, calibrator battery, battery charger, misc banana plugs, calibration screwdriver; <i>Attache' Space For:</i> instruction manuals, microphone calibration curves, data sheets, misc items.
1982-9620	1987-9700	
1982-9630	1986-9700	

*Foam-plastic compartment is specially shaped for particular calibrator.

† Refer to Figure 1-3 and Table 1-4; consult GenRad catalogue for other system configurations.



Figure 1-3. Sample system showing 1982-9630 carrying case, 1982 SLM, 1986 calibrator and typical components compatible with case.

Table 1-4
ACCESSORIES AVAILABLE

Name	Description	Catalog Number
Microphones	Electret-condenser, 1/2" dia; – flat random-incidence response	1962-9610
	– flat perpendicular-incidence response	1962-9611
Microphones	Electret-condenser, 1" dia; – flat random-incidence response	1961-9610
	– flat perpendicular-incidence response	1961-9611
Battery Pack	Assembly containing 3 rechargeable Ni-Cd cells	1981-9602
Sound-Level Calibrators (3)	(1) 1986 OMNICAL: 6 ANSI-preferred frequencies from 125 Hz to 4 kHz; 5 sound-pressure levels (SPL) from 74 to 114 dB; 3 tone-burst signals for checks of fast and slow detector response and rms accuracy.	1986-9700
	(2) 1987 MINICAL: single frequency of 1 kHz; 2 SPL of 94 and 114 dB.	1987-9700
	(3) 1562-A: 5 ANSI-preferred frequencies from 125 Hz to 2 kHz; single SPL of 114 dB.	1562-9701
Audiometer Calibration Accessory Kit	Extends measurement capabilities of 1982 to include audiometer calibration. Kit includes calibration stand, earphone coupler, 1-in. microphone and adaptor (1 in. to 1/2 in.), and calibration chart.	1560-9619
Recorder	Dc, strip chart, 10-cm scale for 50-dB span of sound levels, 12 feed rates; uses Z-fold paper.	1985-9700
Microphone Extension Cable	60 ft (18 m), connects between preamplifier and 1982.	1933-9601
Microphone Extension Cable	20 ft (6 m), connects between preamplifier and 1982	1933-9614
Adaptor Cables	Connects to outputs, all 3 ft. (0.9m) long	
	Miniature phone plug to GR 274 double banana plug	1560-9677
	Miniature phone plug to BNC male	1560-9679
	Miniature phone plug to standard (0.250 inch dia.) phone plug	1560-9678
	Miniature phone plug to standard phone jack	1560-9680
Dummy Microphone	35 pF, BNC female input; simulates 1962-9601/-9602 microphones	1560-9609
Dummy Microphone	22 pF, BNC female input; simulates 1962-9610/-9611 microphones	1962-9620
Attenuator	10 dB Microphone Attenuator to extend range to 150 dB peak.	1962-3210
Windscreen	For 1/2" microphone (package of 4 pcs.)	1560-9522
Tripod	Will accept either 1982 or microphone on cable	1560-9590



Figure 1-4. Removal of Battery Compartment Cover

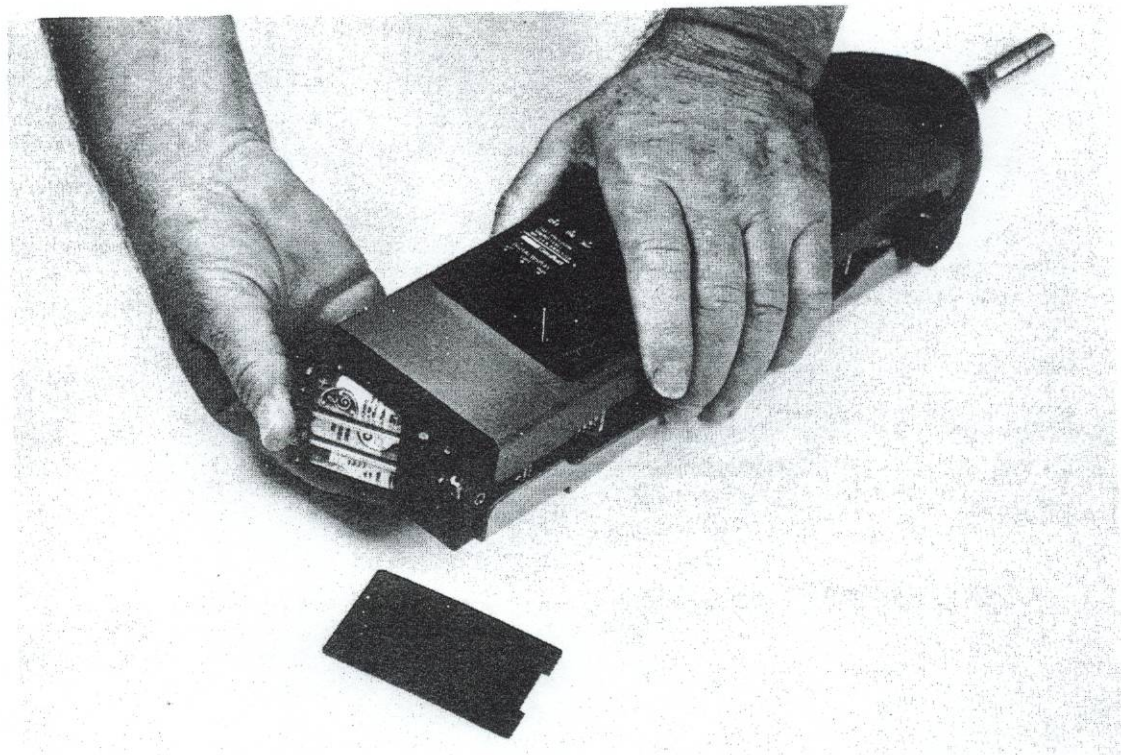

Figure 1-5 Installation of Battery Pack

1.6 INITIAL SET-UP PROCEDURE

The following paragraphs contain the initial set-up procedures for the operation of the GR 1982.

Measurement considerations and operation of the GR 1982 are covered in paragraphs 1.7 through 1.9. The initial set-up of the GR 1982 presupposes that the instrument and accessories have been removed from their shipping containers.

1.6.1 Battery Installation

The GR 1982 is shipped with the batteries removed. The instrument is supplied with a rechargeable battery pack containing three AA-size nickel-cadmium rechargeable cells. However, the instrument may be operated with three AA-size alkaline batteries (Mallory MN1500 or equivalent). The rechargeable battery pack will operate the instrument for a period of 3.0 to 4.25 hours between 4-hour rechargings. The AA-alkaline batteries will operate the instrument for approximately 6 to 8 hours.

To install the batteries proceed as follows:

- a. Rechargeable Battery Pack
 1. Hold the 1982 with the microphone down, slide the bottom cover off as shown in Figure 1-4.
 2. Hold the battery pack so that the words THIS SIDE UP are visible and the exposed "+" signs are at the opposite end from the coil springs (Figure 1-5).
 3. Place the battery pack against the springs and push to compress the springs. Simultaneously push the other end of the pack down into the compartment (Figure 1-5).
 4. Slide the battery compartment cover – end with the notch first and the bow up – into the grooves on the bottom of the battery compartment (Figure 1-4).
- b. Alkaline Batteries
 1. Perform step a.1, above.
 2. Place each cell into the battery compartment as described in a.3 above, observe the polarity as printed on the bottom of the battery compartment.
 3. Install battery compartment cover as described in step a.4.

1.6.2 CHARGING THE BATTERY

The battery pack supplied with the 1982 may arrive partially or completely discharged.

CAUTION

Do not attempt to charge any batteries other than the rechargeable battery pack supplied with the 1982. Any attempt to charge non-rechargeable cells can cause them to overheat and subsequently to explode. Do not attempt to defeat the interlock that is intended to prevent damage that could result from recharging AA primary cells.

To charge the 1982 battery pack, proceed as follows:

- a. Install the battery pack as described in paragraph 1.6.1.
- b. Use the calibration screwdriver, supplied with the 1982, to slide the line voltage switch located on the bottom of the battery charger to the appropriate position (120 or 240) for the line voltage to be used.
- c. Plug the battery charger output connector into the BATTERY CHARGE jack on the 1982 (Figure 1-1, item 13).

NOTE

The 1982 may be operated while the battery charger is connected and ON, but its digital display should be OFF to prevent excessive draw on charger current by the LED's.

- d. Connect the battery charger line cord into the ac power receptacle.
- e. With the power switch on the 1982 (Figure 1-1, item 1) in the OFF position, full recharge can be accomplished in 4 to 5 hours.

Avoid Overcharging. Optimum battery charge time should about equal discharge time but remain within the specified 4 to 5 hour limit. All charge beyond optimum is overcharge and is excess energy dissipated as heat. Within the cells, the heat produces gas, raising internal pressure. Normally, the cells' chemicals reabsorb the gas as pressure increases, and a safety vent protects against the possibility of bursting. However, the overcharge does strain the battery, and it must therefore be avoided.

Temperature has some effect on the capacity of the battery pack and on the length of time it will provide power. For best results the battery pack should be recharged at room temperature. If the battery is recharged at 40°C (104°F), it will provide only 60 percent of the capacity available after a room-temperature or low-temperature charge. Also, if the 1982 is operated in temperatures below 0°C (32°F), the battery will produce only about 90 percent of its rated capacity.

Avoid very cold charging. There is a low-temperature limit for charging because the gas-absorbing chemical reactions do not work at low temperatures. Even moderate charging below a temperature of 15°C (59°F) can generate enough gas to open the safety vent. Therefore, be sure to keep the temperature above 15°C (59°F) while charging the battery.

If the safety vent opens, (an occurrence difficult to detect) the battery loses some of its electrolyte. The result is degradation and ultimate failure of the battery, i.e., loss of capacity to store electrical energy.

Extreme Discharge. Do not allow the battery to become fully discharged. Perform battery checks (see paragraph 1.6.3) at recommended intervals. Slide the power switch to OFF upon completion of each test. The decimal point in the digital display remains visible to serve as a reminder while power is ON.

Memory. Nickel-cadmium batteries tend to lose charge capacity with disuse or after many cycles of very light use. This phenomenon, called "memory," results in a condition where the battery will appear to be fully charged but will fail to perform for the expected 3.5 to 5 hours. Fortunately, a "memory" condition can be remedied by reconditioning the battery. Proceed as follows to recondition the battery:

- a. Discharge the battery fully by operating the 1982 (with the digital display OFF) for about 24 hours.
- b. Perform a slow charge, with power ON and digital display OFF, for 24 hours.
- c. Repeat this cycle as necessary to restore full charging capacity.

Extending Battery Life. Nickel-cadmium batteries respond best to moderation in usage and handling. Avoid excess discharge and overcharging. Limit exposure to temperature extremes. During charge periods, be sure line voltage stays within the selected range on the battery charger line-voltage switch.

Storage. Nickel-cadmium batteries may be stored in either a charged or partially charged condition. They undergo self-discharge at a rate of 10 to 25% per month. Thus, after prolonged storage (3 months or more), they require a new charge. If "memory" becomes a problem, perform the reconditioning process (see Memory, above).

WARNING

Never discard batteries in a fire or in trash to be burned, as they can explode and cause serious injury.

1.6.3 Battery Check

Battery check should be performed before each measurement period and every 30 minutes during operation. A fully charged battery usually moves the meter pointer to the lower ¼ of the BAT OK area.

To check the battery, proceed as follows:

- a. Install and charge (if necessary) the batteries as described in paragraphs 1.6.1 and 1.6.2.
- b. Slide the power switch (Figure 1-1) to the ON position and then to the BAT position and hold.
- c. Check the digital display for a reading of 888.8 and the meter for a steady indication of BAT OK. These show the battery to be sufficiently charged for proper operation of the 1982.

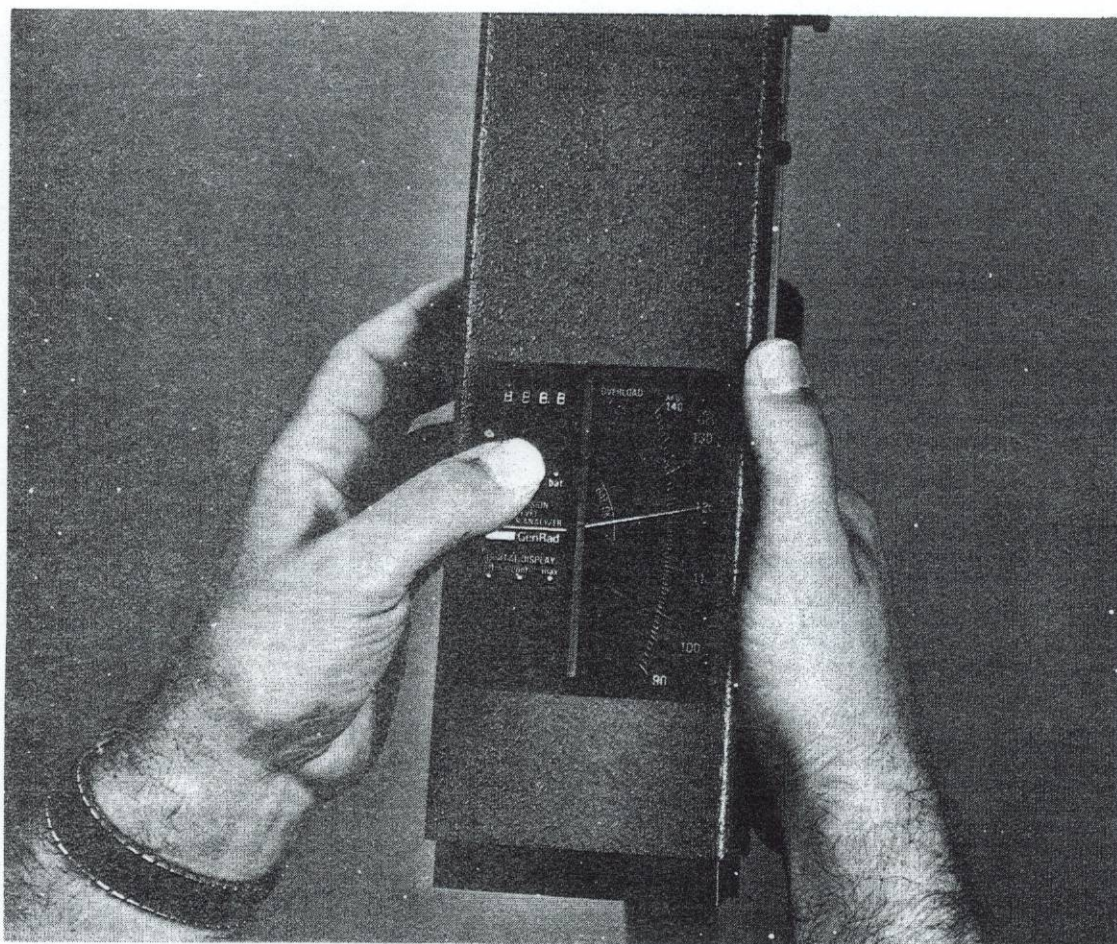

Figure 1-6. Battery Check

d. If the results in step c cannot be obtained, refer to paragraph 1.6.2 for battery-charging information or to paragraph 1.6.5 for battery removal.

The meter serves as a battery voltage indicator while the power switch is held in the BAT position. Since battery voltage is related to its stored energy, the meter reading gives some indication of the operating time that remains before the battery becomes discharged. This information is particularly useful when non-rechargeable cells are used. It is less useful with the nickel-cadmium rechargeable battery pack, because it maintains a relatively constant output voltage during use, until nearly all of its energy has been spent.

1.6.4 Calibration Of Sensitivity

To ensure optimum accuracy of sound-pressure-level (SPL) measurements made with the 1982, its sensitivity should be checked with a calibrated input signal *before* and *after* each measurement period. The procedure should be performed in the same environment used for measurements.

The procedure below checks the sensitivity level and overall gain (dB) of the total system that is calibrated. This system should include all instruments and components to be used in the measurement system, such as a microphone extension cable (1933-0220, -9601 or -9614), attenuator, printer, or any other measurement accessory utilized.

It is recommended that the GR 1986, 1987 or 1562 be used to calibrate the 1982; the GR 1567 can also be used. Some of these calibrators have the capability to perform calibration checks other than a check of sensitivity level (dB). Since the sensitivity check is the only calibration procedure required on a daily basis, however, it is the only check described below. Refer to para 3.3.1 or the calibrator's instruction manual for other calibration checks which can be performed at periodic intervals.

- a. Verify the calibrator's battery, as described in the instrument's instruction manual.
- b. Verify the 1982 battery, as described in para 1.6.3 of this manual.
- c. If the calibrator has more than 1 output frequency, set the appropriate control to **1 kHz**. (On the GR 1986 calibrator, set VARIABLE SPL control to CALIBRATED SPL.)
- d. If the calibrator has more than 1 output level (dB), set the appropriate control to the level (dB) that best approximates the levels to be measured by the 1982. If the measured levels are not known, set this control to either 114 dB or 94 dB.
- e. On the 1982, set the dB RANGE control to the lowest possible range that has an upper limit above the 1986 level (dB) selected in step d. Set other 1982 controls as follows.

Power	ON
DIGITAL DISPLAY	cont
OCTAVE FILTER FREQ Hz	WTG
WEIGHTING	A
DETECTOR	SLOW

- f. Insert the calibrator's 1/2-in. microphone adaptor into its microphone cavity so that the cavity will conform to the 1/2-in. microphone on the 1982. The 1987-7061

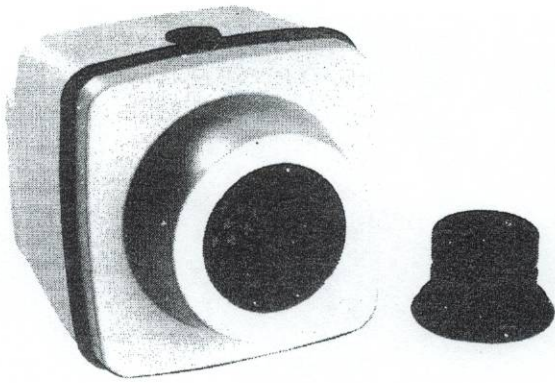

Figure 1-7. GR 1987 calibrator with 1987-7061 1/2-in. microphone adaptor.

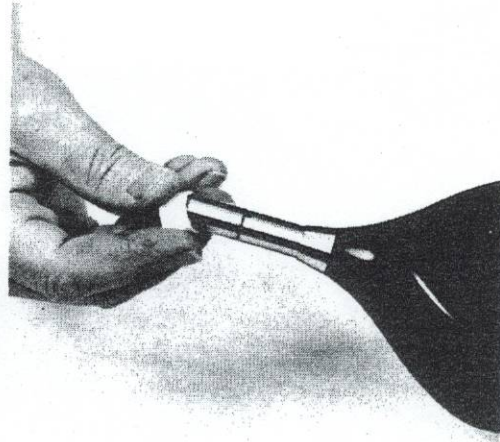

Figure 1-8. Removal of microphone dust cover.

adaptor (Figure 1-7) is used on the 1987 and 1986 calibrators, the 1562-6130 adaptor on the 1562 and 1567 calibrators.

g. Remove the protective microphone cover from the 1982 (Figure 1-8).

h. Carefully place the calibrator's cavity over the microphone of the 1982 (Figure 1-9). If the 1982 is to be used with a microphone extension cable (1933-0220, -9601 or -9614), the calibration should be performed with the microphone and preamplifier connected to the cable.

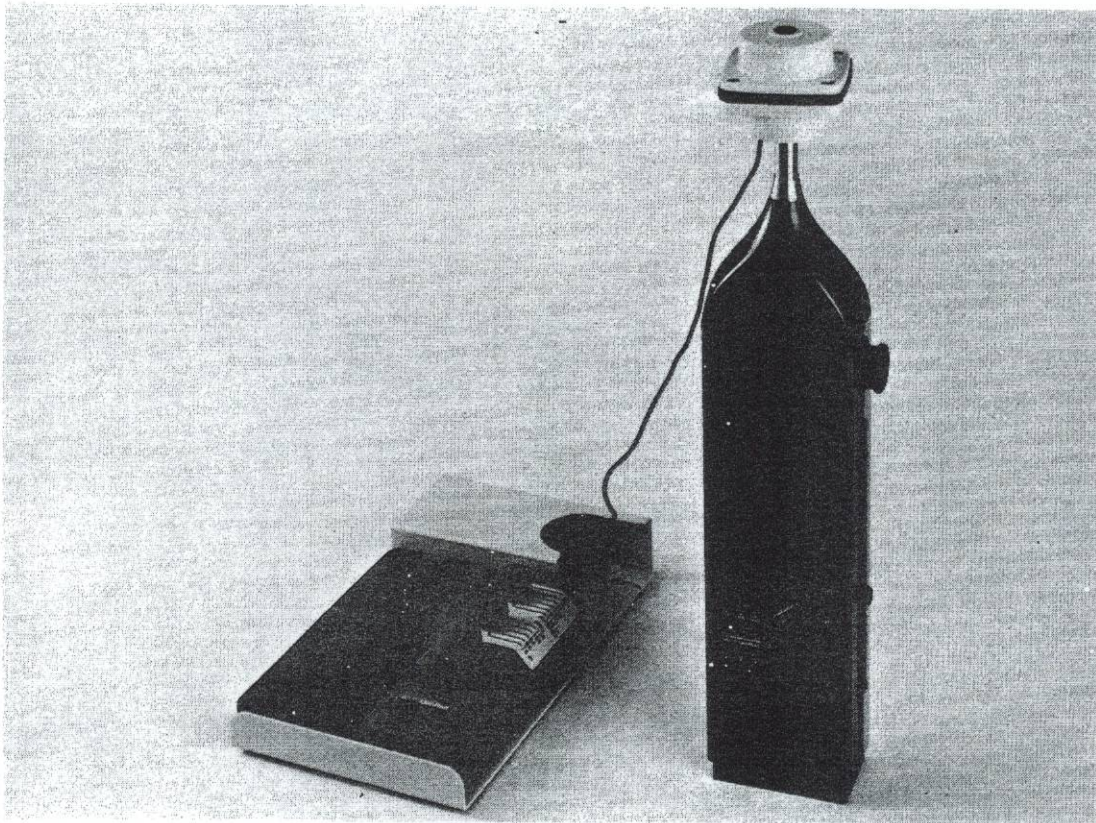

Figure 1-9. Typical calibration setup with the GR 1986 calibrator.

i. Read the level (dB) indicated by the 1982 meter and digital display. If the ½-in. random-response microphone (1962-9610 or -9601) is used on the 1982, no correction is necessary for microphone response. If, however, a microphone other than the above is used, it may be necessary to apply a microphone-response correction (dB) to the 1982 reading (dB); refer to the calibrator's instruction manual for applicable microphone correction factors.

j. The calibrator's output level (dB) is affected negligibly by normal temperature or pressure variations. If, however, the atmospheric pressure varies significantly from a value of 760 mm of Hg, it may be necessary to apply an atmospheric pressure correction (dB) to the calibrator's output level (dB); refer to the calibrator's instruction manual for applicable atmospheric pressure corrections.

k. Compare the 1982 reading (dB) obtained in step i with the calibrator's output level (dB) obtained in step j. If they are not the same, use the calibration screwdriver (Figure 1-10) to adjust the 1982 CAL control until the 1982 reading matches the calibrator's output level.

l. Switch the 1982 OCTAVE FILTER FREQ control to the **1 kHz** position, and observe the front-panel reading (dB). It should be within ± 0.5 dB of the reading that was displayed before the control was switched.

NOTE

If requirement of step l is not met, 1982 is operating improperly.
Consult nearest GenRad facility for assistance.

- m. Remove the calibrator and turn off its power.
- n. Proceed to para 1.7 thru 1.9 to perform measurements.

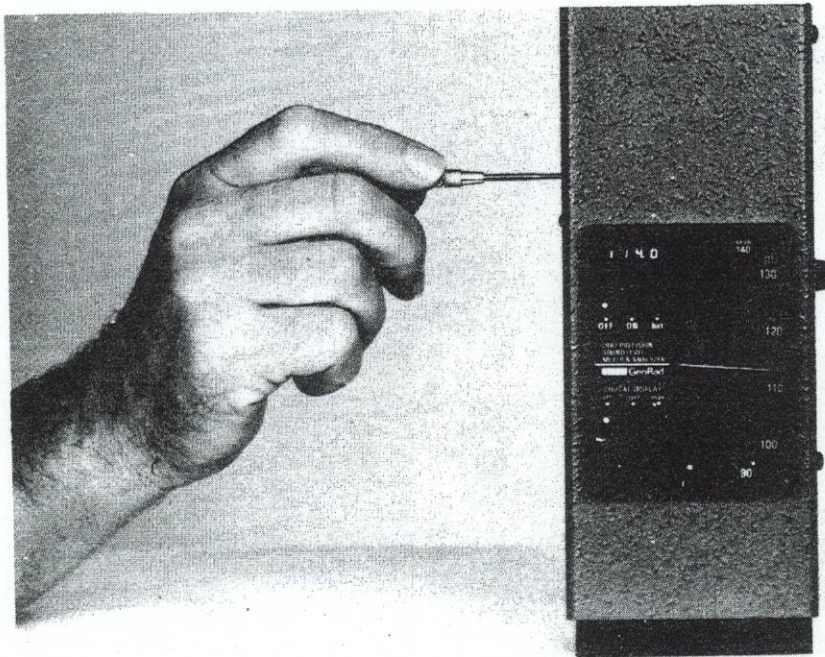

Figure 1-10. Use of calibration screwdriver to adjust 1982 CAL control (left panel).

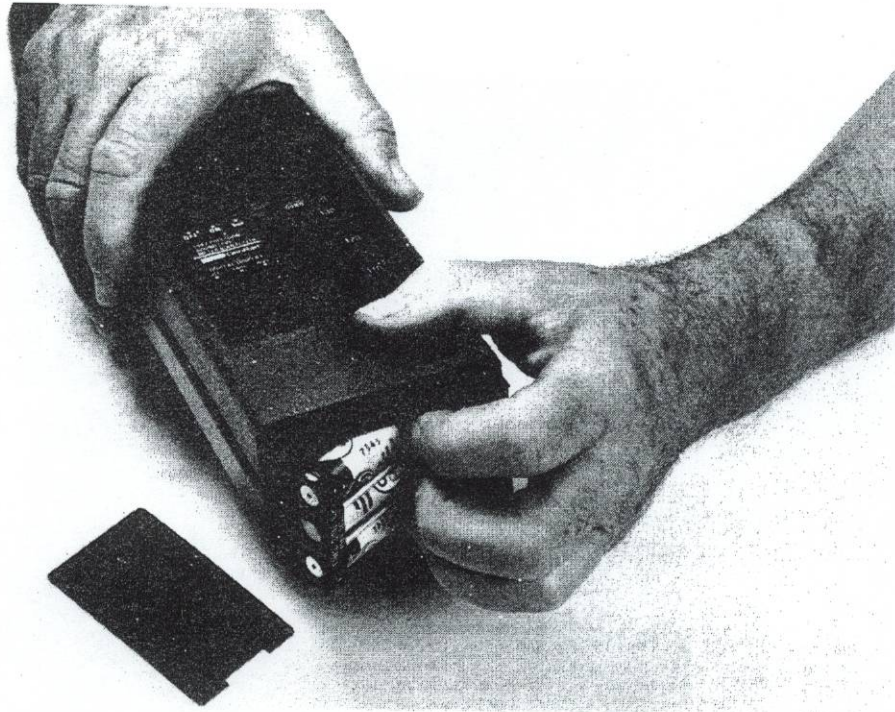

Figure 1-11. Battery Pack Removal

1.6.5 Battery Removal

To remove the batteries for replacement or storage proceed as follows:

NOTE

Batteries should be removed from the 1982 whenever it will not be used for one week or more.

- a. Rechargeable Battery Pack
 1. Hold the 1982 with the microphone end down, slide the bottom cover off as shown in Figure 1-4.
 2. With the fingers grasp the battery pack by the end nearest to the springs and squeeze with a lifting motion (Figure 1-11) to raise the other end of the battery pack.
 3. Remove the battery pack from the battery compartment.
 4. Replace the battery compartment cover (1.6.1 a.4).
- b. Alkaline Batteries
 1. Remove battery compartment cover (1.6.1 a.4).
 2. Depress the battery against the spring and lift.
 3. Remove the three batteries.
 4. Replace the battery compartment cover (1.6.1 a.4).

1.6.6 Placement of Components In Carrying Case

There are three 1982 carrying cases to accommodate different sound-measurement-system configurations (refer to para 1.5). The components that comprise such a system are either supplied with the 1982, or ordered separately as accessories (see Tables 1-3, 1-4). Each component should be placed in the appropriate specially-shaped foam-rubber compartment provided in the carrying case.

Figure 1-12 shows a typical measurement system after it has been properly packed in a carrying case. The particular carrying case illustrated in the figure is the 1982-9610, which is designed for the 1562 calibrator (shown in front compartment with dial facing toward front).

NOTE

Sleeve (½-in. or 1-in.) must be removed from tripod before it is placed in carrying case.

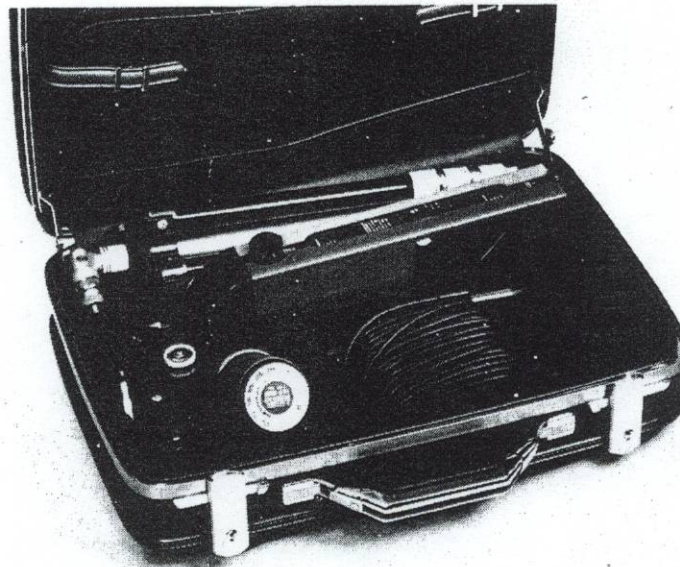

Figure 1-12. Placement of Components in Carrying Case

1.7 MEASUREMENT CONSIDERATIONS

1.7.1 Introduction

Much care is exercised in the design and manufacturing of Type-1 instruments, but this only assures that the use of a "Precision" instrument will contribute negligible error to the measurement results. In order to make valid, repeatable measurements, it is helpful to recognize that the results of a measurement are determined by a number of factors, among which are the following:

- a. The phenomenon being measured.
- b. The effect of the measurement process on the phenomenon being measured.
- c. The environmental conditions.
- d. The calibrations of the transducers and instruments at the time they are used.
- e. The way the transducers and instruments are used.
- f. The observer.

1-16 OPERATION

It is generally a good policy to measure sound in accordance with a standard procedure. The standards have been prepared to help obtain valid data. They are useful guides for the inexperienced user, and can help the experienced user by listing the steps required in a measurement procedure. Standards help to make comparisons of measured results more meaningful.

NOTE

The general standard ANSI S1.13-1971, "Standard Methods for Measurement of Sound-Pressure Levels," is particularly recommended.

An obvious and important step in any measurement task is to verify that the results are reasonable. If they are not, try to determine possible causes of inconsistencies. Some common causes include: background noise, poor connections, plugs in the wrong places, no power, batteries partially discharged, controls set incorrectly, damaged equipment, stray grounds, and electrical interference pickup.

The results of a noise measurement may be a key factor in resolving a noise problem. In addition, the experience and data can help to solve other noise problems. Careful records of noise measurements can be a valuable reference in the solution of subsequent noise problems.

A recognition of the accuracy limitations of acoustic and vibration measurements is important in the solution of any measurement problem. Thus, consistency to ± 0.1 dB or better is attainable in only a few laboratory calibration procedures and not in general acoustical measurements. Field calibrations of sound-level meters at one frequency with a calibrator may be consistent to ± 0.5 dB or slightly better. In general, a consistency of ± 1.0 dB is difficult to attain, even under carefully controlled conditions.

1.7.2 Effects of Instrument Case and Observer

NOTE

For precise measurements in a very dead room, such as an anechoic chamber, the instruments and the observer should be outside, with only the source, microphone, extension cable, and a minimum of supporting structure in the dead room.

The observer can affect the measured data if he is close to the microphone. When measurements are made in a live room (an ordinary room) and not close to a source, the effect is usually not important. But if measurements are made near a source, it is advisable that the observer stand well to the side of the direct path between the source and the microphone.

For many measurements, it is most convenient to be able to carry the sound-level meter around. In order to obtain the best results when making hand-held measurements, hold the sound-level meter as described in the following paragraphs.

NOTE

If the microphone is mounted on the sound-level meter, do **NOT** make measurements with the hand on the top part of housing. Support the main chassis for best results.



Figure 1-13. Random Response Microphone in Use

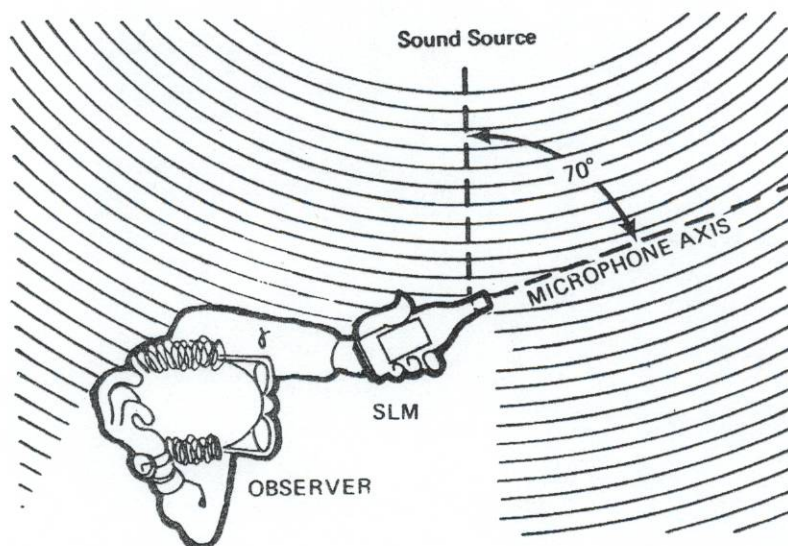

Figure 1-14. Orientation of Hand-held SLM with Random Microphone

1.7.3 Using Random Response Microphone.

NOTE

For detailed procedures refer to paragraphs 1.8 and 1.9.

If microphone being used is the flat-random-incidence-response type (part of 1982-9700), position it as follows:

- a. Microphone on the sound level meter.
 1. Hold the instrument in left hand as shown in Figures 1-13 and 1-14.
 2. Stand so the sound source is to the left.
 3. Hold the 1982 out at arm's length and point it 70 degrees away from the sound source. Notice that this 70 degree angle can be horizontal as pictured, or vertical (point the microphone 70 degrees above the sound source), or in between.
- b. Microphone Remote (with preamplifier).
 1. Mount the microphone on a tripod (Figure 1-15) as described in detail in Section 1.10.
 2. Maintain the same 70 degree angle between the microphone and the sound source.

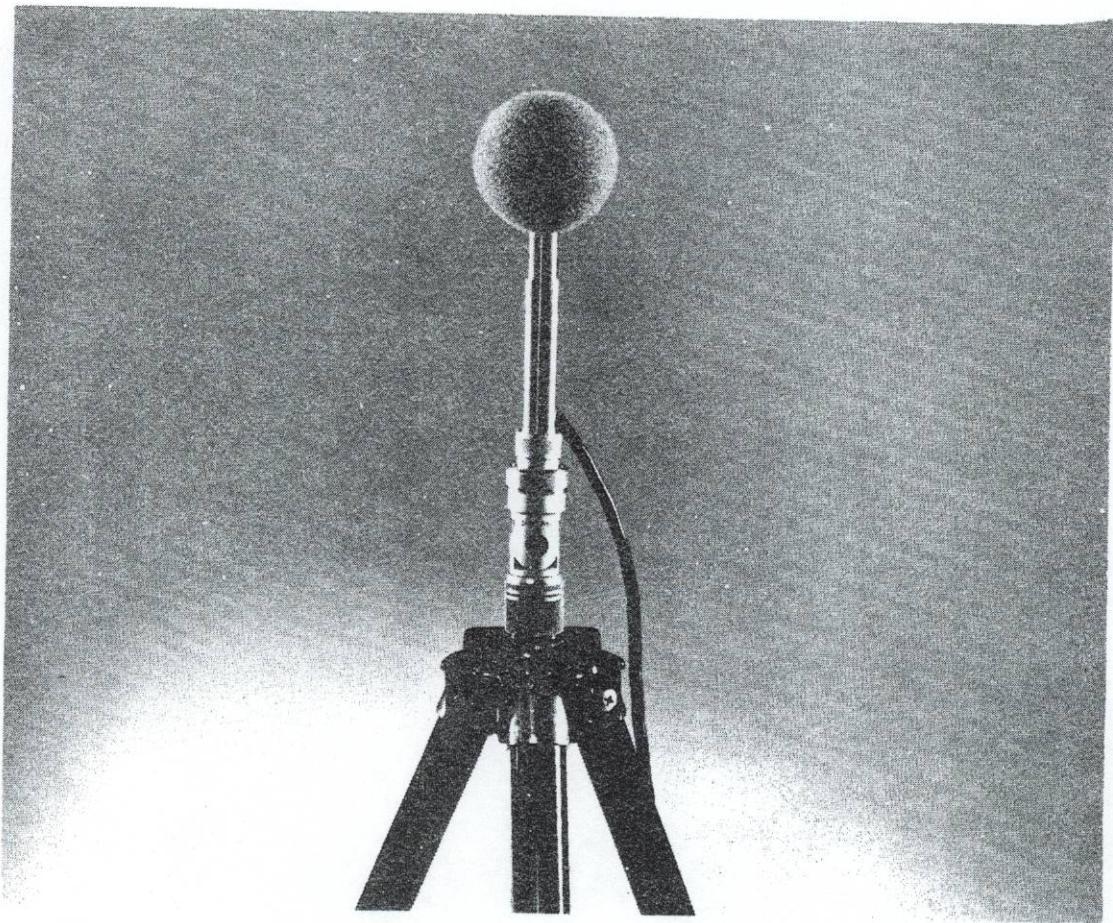

Figure 1-15. Microphone on Tripod

1.7.4 Using Perpendicular Response Microphone

NOTE

For detailed procedures refer to paragraphs 1.8 and 1.9.

If microphone being used is the flat-perpendicular-incidence-response type (part of 1982-9710), position it as follows:

- a. Microphone on sound level meter.
 1. Hold the 1982 in left hand as shown in Figures 1-16 and 1-17.
 2. Stand so that the sound source is to the left and slightly to the front.
 3. Extend the 1982 to arm's length and point the microphone toward the sound source.

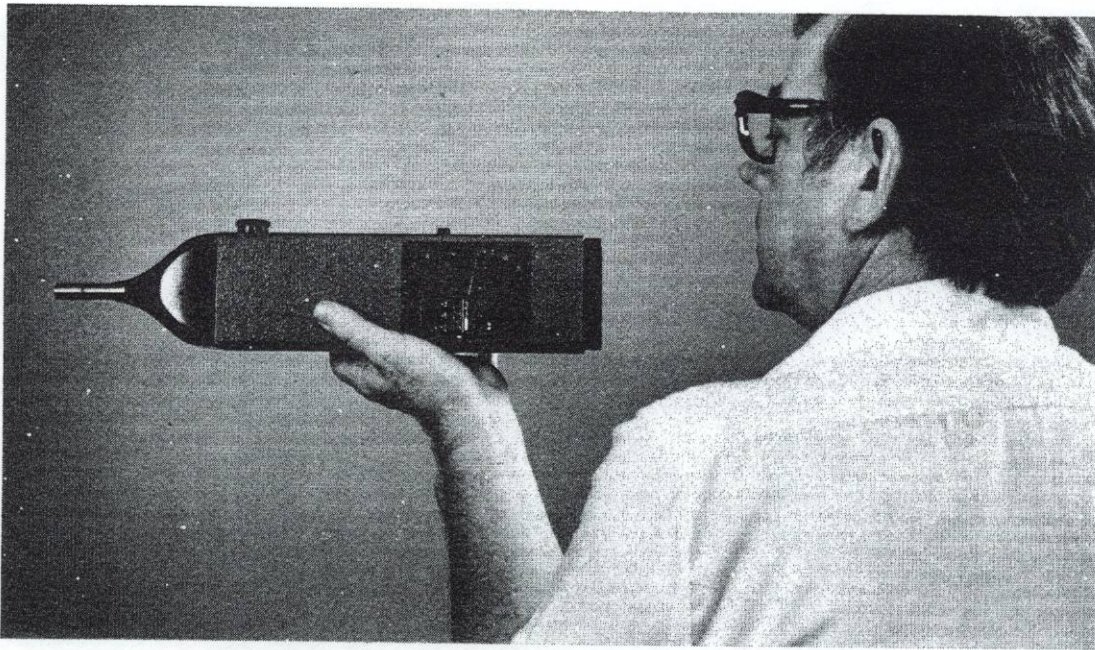

Figure 1-16. Perpendicular Response Microphone in Use

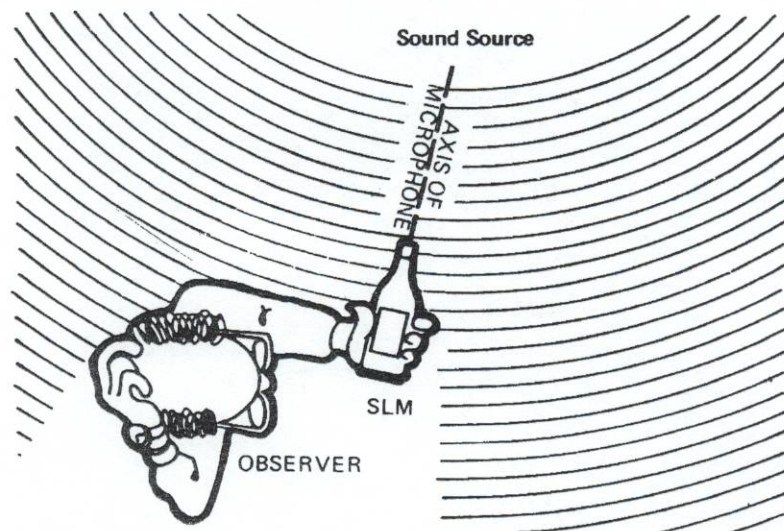

Figure 1-17. Orientation of Hand-held SLM with Perpendicular Microphone

b. Microphone Remote (with preamplifier).

1. Mount the microphone on a tripod (See Figure 1-15) using the procedure of Section 1.10.
2. Maintain the standard 70 degree angle between microphone and sound source.

1.7.5 Characteristic Response Curves

Figure 1-18 consists of five graphs which describe the characteristics of the two microphones 1962-9610 and 1962-9611. These curves are for microphones extended on a 10-foot cable with preamplifier.

Figure 1-19 consists of two graphs which describe the characteristics of the two microphones 1962-9610 and 1962-9611. These curves are for microphones positioned on the 1982 SLM.

1.7.6 Background Noise

Ideally, when a sound source is measured, the measurement should determine only the direct airborne sound from that source, without any appreciable contribution from noise produced by other sources. In order to ensure such a separation, the measurement space may need to be isolated from external noise and vibration. As a test to determine that this requirement has been met, the American National Standard Method for the Physical Measurement of Sound, S1.2, specifies the following:

"If the increase in the sound-pressure level . . . , with the sound source operating, compared to the ambient sound-pressure level alone, is 10 dB or more, the sound-pressure level due to both the sound source and ambient sound is essentially the sound-pressure level due to the sound source. This is the preferred criterion."

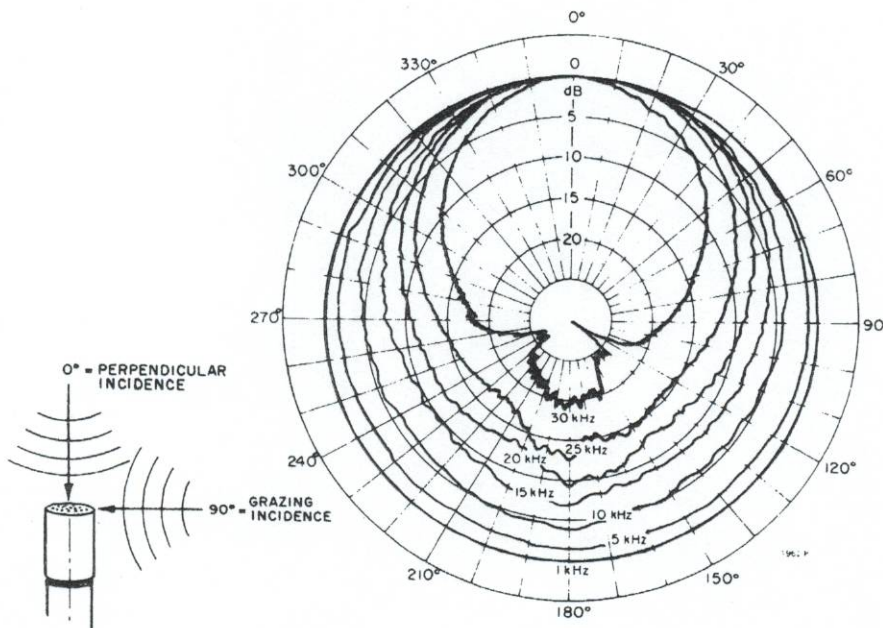

Typical directional response of either microphone.

Figure 1-18. Characteristic Response Curves (microphone only)
(Continued on next page)

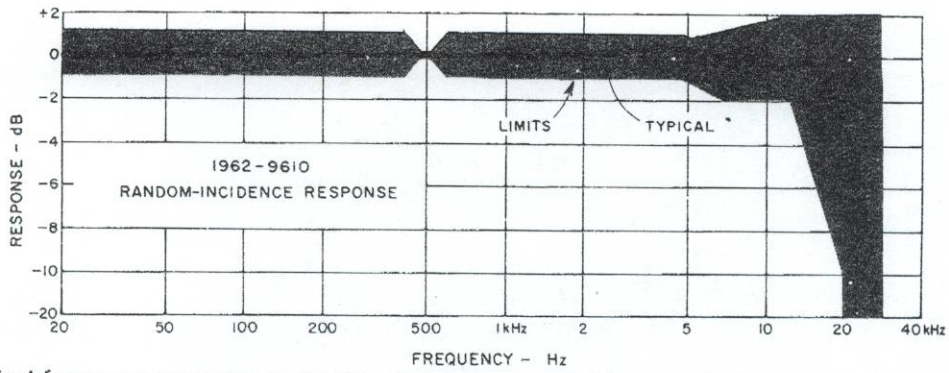

Typical frequency response to random-incidence sound. (Acceptable in gray area.)
 Characteristics of the 1/2-in. flat-random-incidence-response electret-condenser microphone.

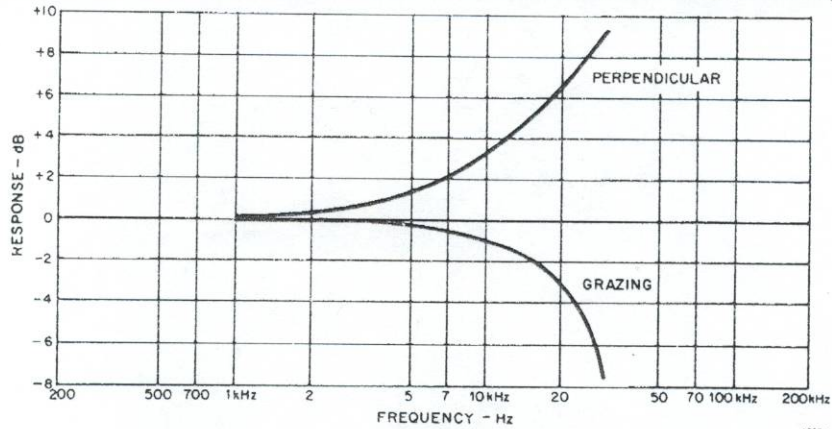

Corrections to be added algebraically to random-incidence response level to find perpendicular- and grazing-incidence free-field response levels.

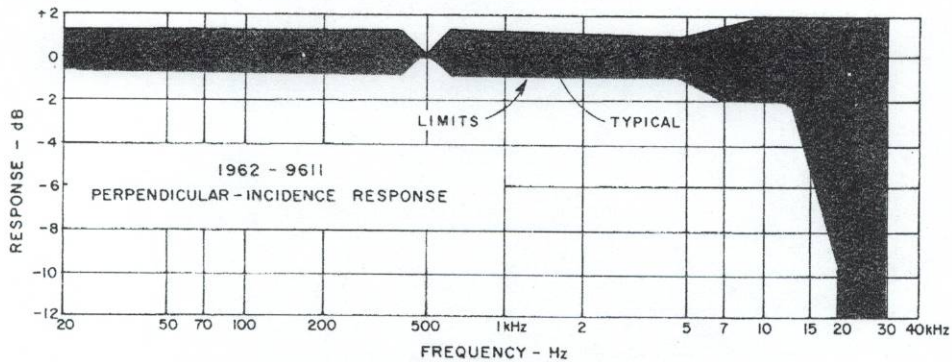

Typical frequency response to perpendicular-incidence sound. (Acceptable in gray area.)
 Characteristics of the 1/2-in. flat-perpendicular-incidence-response electret condenser microphone.

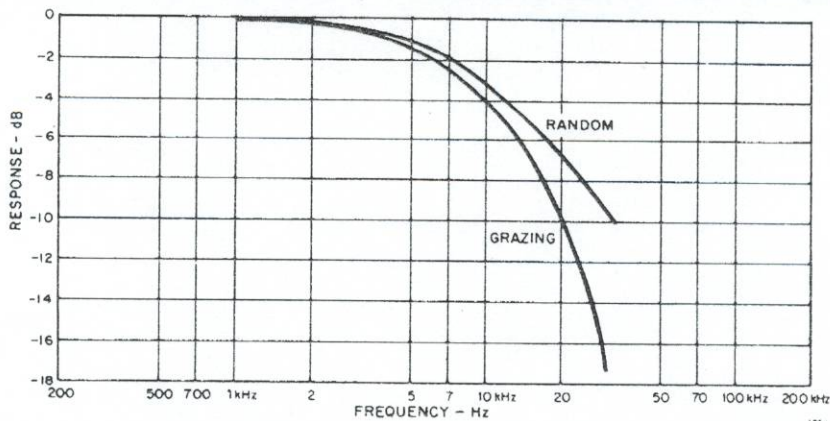

Corrections to be added algebraically to perpendicular-incidence response level to find random- and grazing-incidence free field response levels.

Figure 1-18. Characteristic Response Curves (microphone only)

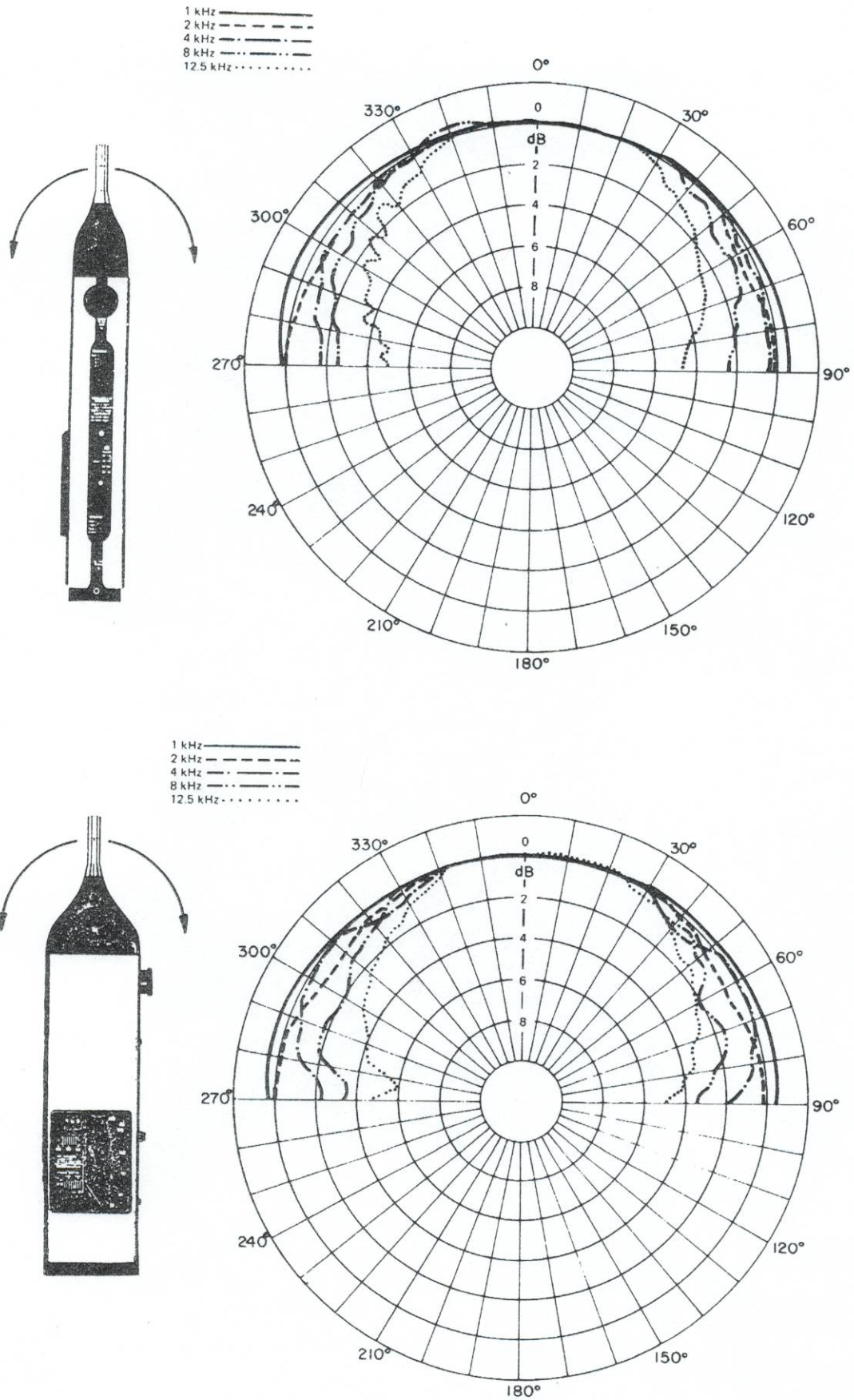

Figure 1-19. Directivity Response Curves (microphone on SLM)

If both the background noise level and the noise level being measured are steady, a correction can be applied to the measured data as indicated in the graph in Figure 1-20. Proceed as follows:

a. Select the test position for the microphone in accordance with specifications of the pertinent code or procedure.

NOTE

Refer to the *Handbook of Noise Measurement**, for additional sound measurement information.

- b. Orient the microphone as described in paragraph 1.7.4.
- c. Measure the background noise with the "device under test" (DUT) quiescent.
- d. Measure the "total" sound-level with the DUT operating.
- e. Evaluate the significance of background noise in your measurement and take steps to reduce it, if necessary, as discussed below.

The difference between the sound-level with the DUT operating and the background noise level determines the correction to be used. If this difference is less than 3 dB, the noise contribution of the DUT is less than the background noise; and the level obtained by use of the correction should be regarded as only indicative of the true level and not as an accurate measurement. If the difference is greater than 10 dB, the background noise is negligible and the reading with the DUT operating is the desired measurement.

The following is an example of a situation which falls between those two extremes. The background noise level is 77.5 dB, and the total noise with the DUT operating is 83.5 dB. The correction factor, obtained from Figure 1-20 for a 6.0-dB difference, is 1.2 dB, so that the corrected level is 82.3 dB.

*See Condensed Operating Instructions at beginning of manual.

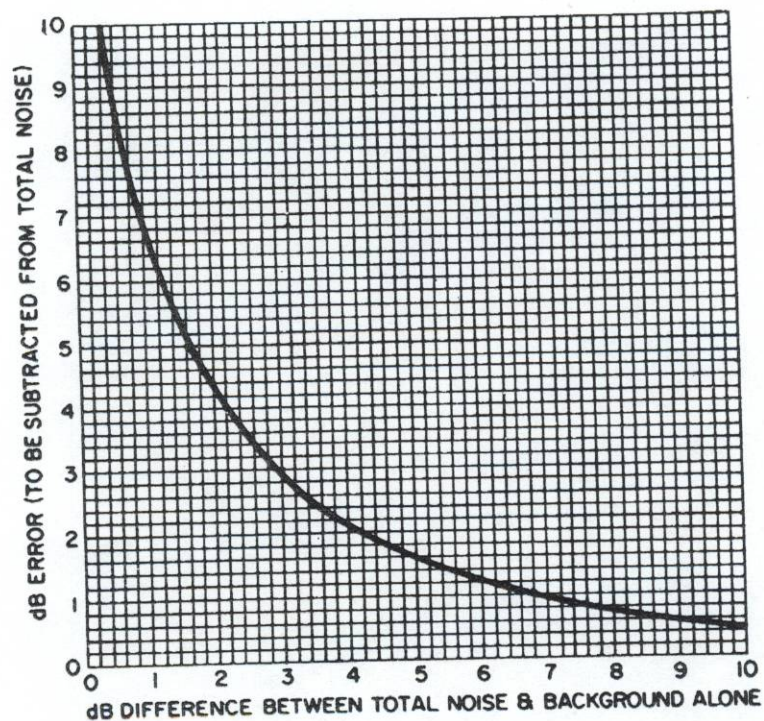

Figure 1-20. Background Noise Correction for SL Measurement

If this difference between background level and total noise level is small, an attempt should be made to lower the background level. Usually the first step is to isolate the source or sources of this background noise to reduce the noise directly. The second step is to analyze the transmission path between the source and the point of measurement. This step may mean simply closing doors and windows, if the source is external to the room, or it may mean erecting barriers, applying acoustical treatment to the room, and opening doors and windows, if the source is in the room. The third step is to improve the difference by the method of measurement. It may be possible to select a point closer to the apparatus, or an exploration of the background noise field may indicate that the microphone position can be shifted within the specifications to a point where this noise is at a minimum (yet allowing proper orientation with respect to the device under test). Chapter 8 of the GenRad *Handbook of Noise Measurement* by Peterson and Gross, contains particularly useful information about sound measurements and sound fields.

1.7.7 Overload Levels

Figure 1-21a indicates the maximum sound-pressure levels that may be applied to the instrument for each setting of the dB-Range control and for the various weightings.

1.7.8 Data Recording

An important part of any measurement program is obtaining and recording meaningful data. The use of data sheets designed specifically for a noise problem ensures that the desired information will be recorded. Below is a checklist of items which can be useful in recording measurement data or preparing suitable data sheets:

- a. Description of space in which measurements are made. Nature and dimensions of floor, walls, and ceiling. Description and location of nearby objects and personnel.
- b. Description of DUT (primary noise source). Dimensions, name-plate information and other pertinent facts including speed and power rating. Kinds of operations and operating conditions. Location of device and type of mounting.

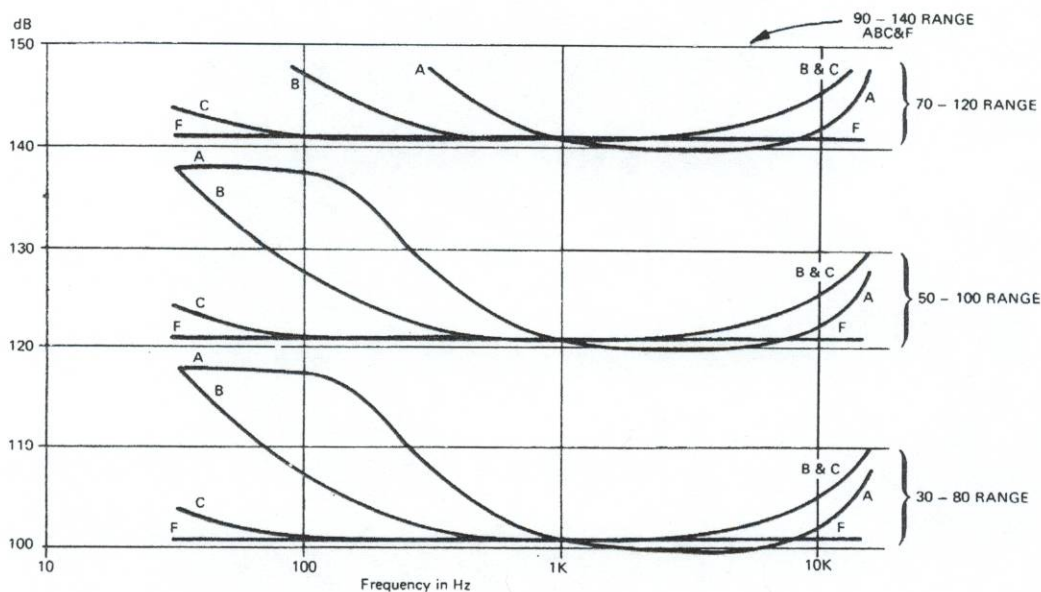

Figure 1-21a. Peak Sound Levels for the SLM

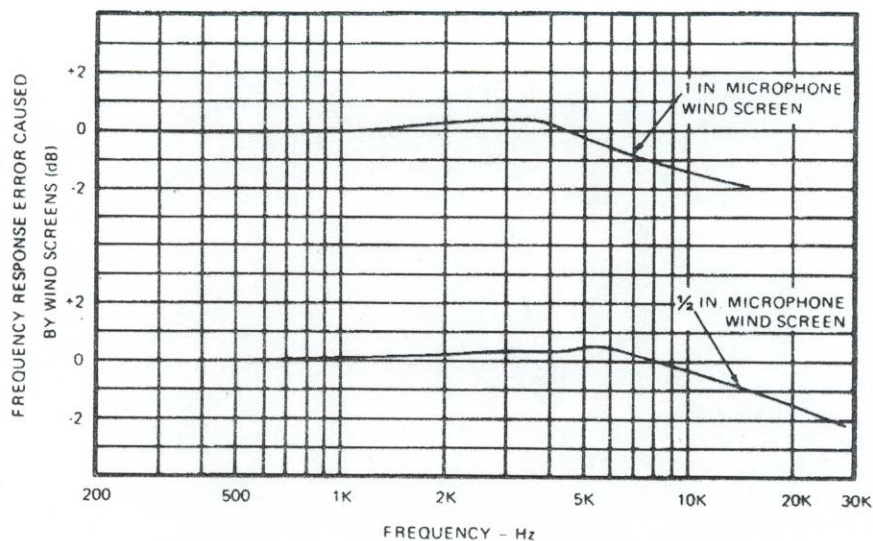

Figure 1-21b. Effect of Windscreens.

- c. Description of secondary noise sources. Location and types. Kinds of operations.
- d. Type and serial numbers on all microphones, sound-level meters, and accessories used. Length and type of microphone cable.
- e. Position of observer.
- f. Positions of microphone. Direction of arrival of sound with respect to microphone orientation. Tests of standing-wave patterns and decay of sound-level with distance.
- g. Ambient temperature, humidity, barometric pressure and resultant corrections, if any.
- h. Results of maintenance and calibration tests.
- i. Weighting network and dynamic characteristic of indicator.
- j. Measured sound-levels at each microphone position. Extent of meter fluctuation.
- k. Background noise levels at each microphone position, with DUT not operating.
- l. Cable and microphone corrections.
- m. Date and time.
- n. Name of observer. When the measurement is being made to determine the extent of noise exposure of personnel, the following items are also of interest:
 1. Personnel exposed — directly and indirectly.
 2. Time pattern of exposure.
 3. Actions taken to control noise and to protect personnel.
 4. Audiometric examinations — dates, methods, equipment, results, etc.

1.7.9 Microphone Windscreens

Microphone windscreens are used to reduce the effects of ambient wind noise. Wind flowing across the surface of the microphone generates low-frequency noise, which can lead to erroneous measurements. The windscreen also protects the microphone from accumulations of vapor and dust in the work environment.

This accessory fits snugly over the microphone. It is made of reticulated polyurethane foam and can be conveniently removed and washed, or replaced, if it becomes soiled. This is in addition to the obvious advantage of attenuating up to 20 dB of

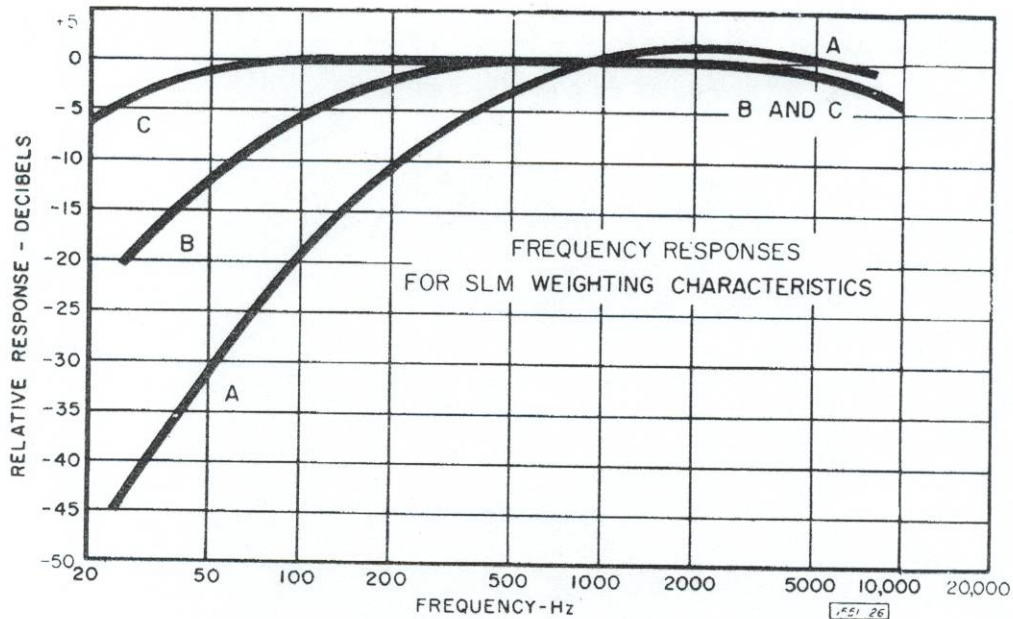

Figure 1-22. Frequency-response characteristics.

ambient wind noises, such as might emanate from a fan blowing cooling air or outdoor winds blowing across the site being monitored. Figure 1-21b indicates the effects of windscreens on microphone response.

1.8 FUNCTIONAL MODES OF THE GR 1982

The following functional modes of the GR 1982 will be discussed:

1. Weighting Networks – A, B, and C
2. Flat Response
3. Meter Response – Fast and Slow
4. Measuring Octave Band Noise
5. Measuring Impulse Noise

1.8.1 Weighting Networks

The GR 1982 contains three weighting networks, A, B, and C which shape the noise to discriminate against the frequency components of the measured noise. The response of the commonly used weighting networks is shown in Figure 1-22. Since the A-weighting network simulates subjective responses to noise, it is generally used in noise surveys to locate noise hazards. Most regulations require that noise be measured on the A-weighting scale.

Sound-pressure level (unweighted) is not a good indicator of subjective response.

Through the use of these networks a sound-level meter can respond selectively to certain frequencies, with a prejudice not unlike that of the human ear. The writers of the acoustical standards have established 3 weighting characteristics, designated

A, B, and C. The chief difference among them is that very low frequencies are discriminated against quite severely by the A-network, moderately by the B-network, and hardly at all by the C-network. Therefore, if the measured sound-level of a noise is much higher on C-weighting than on A-weighting, much of the noise is contributed by the low frequencies.

1.8.2 Flat Response

The GR 1982 can also be used to measure sound in the flat-response mode. In this mode the sound-pressure level is measured without regard to the frequency of the sound. The response is flat from 10 Hz to 20 kHz. This mode is used primarily when the measured noise is to be recorded for analysis at a future time.

1.8.3 Detector Response

The GR 1982 is supplied with four detector response modes — FAST, IMPULSE, PEAK, and SLOW. The FAST and SLOW responses are used to measure continuous noise. The meter response is established by the applicable standards for the SLM and refers to the speed at which the meter responds to a changing signal.

When measuring industrial noises, it will be observed, that most sounds do not give a constant level reading. The reading fluctuates often over a range of a few decibels and sometimes over a range of many decibels, particularly at low frequencies. The maximum and minimum readings should usually be noted. These levels can be entered on the data sheet as, say, 85-91 dB or 88 ± 3 dB.

When an average sound-pressure level is desired and the fluctuations are less than 6 dB, a simple average of the maximum and minimum levels is usually taken. If the range of fluctuation is greater than 6 dB, the average sound-pressure level is usually taken to be 3 dB below the maximum level. In selecting this maximum level, it is also customary to ignore any unusually high levels that occur infrequently.

The SLOW meter response should be used to obtain an average reading when the fluctuations on the FAST position are more than 3 or 4 dB. For steady sounds the reading of the meter will be the same in either the SLOW or FAST response mode, however, with fluctuating sounds, the SLOW response mode provides a long-time average reading.

NOTE

The SLOW meter response is specified when sound is measured for hearing damage risk analysis. It is important to document whether a reading was taken in the FAST or the SLOW meter response position. The IMPULSE and PEAK modes are used to measure short duration sounds. Refer to paragraph 1.8.7 for additional information.

When a random noise is measured, the first important result that is desired is the long-time average energy level. This concept leads to taking the average of the fluctuating pointer reading. If the fluctuations are less than about 2 dB, this average can be easily and confidently estimated to a fraction of a decibel. If the fluctuations cover a range of 10 dB or more, the average is much less certain.

When the fluctuations are large, the nature of the source or sources should be considered. If the noise-generating mechanism shifts from one mode to another, it may be desirable to characterize the noise level by more than one average value.

NOTE

The SLOW meter response to a tone burst of 500 msec duration at 1000 Hz is nominally 4 dB down from a steady reference signal at the same level and frequency. Overshoot response to a suddenly-applied signal that is held constant, is nominally 0 dB in the frequency range from 63 Hz to 8000 Hz.

1.8.4 Octave Band Noise

In order to understand the source of a noise problem and to make a decision concerning possible corrective action, the noise characteristics must be analyzed in octave bands. Noise consists of various frequency components. It is necessary to know the level of the contribution in each frequency band in order to select effective hearing protectors, sound barrier material, or to determine the source of a noise.

Each frequency band has a certain amount of energy which goes into making up the overall pressure level. Figure 1-23 illustrates two noise sources which have the same A-weighted level. As can be seen, each noise has its dominant pressure in a different frequency band. It is well known that absorptive materials are sensitive to frequency and that moving parts generate different frequencies, hence, the solution to these two noise problems will require different approaches.

To generate these types of curves, an octave-band analyzer is required. The octave-band data will give the level of noise in each frequency band. This data will enable the plant engineer to select the proper absorptive material for an enclosure or barrier. It will also enable him to isolate the source of noise in the machine to implement engineering changes. Perhaps it will prove that the bearings are worn or that the machine needs servicing.

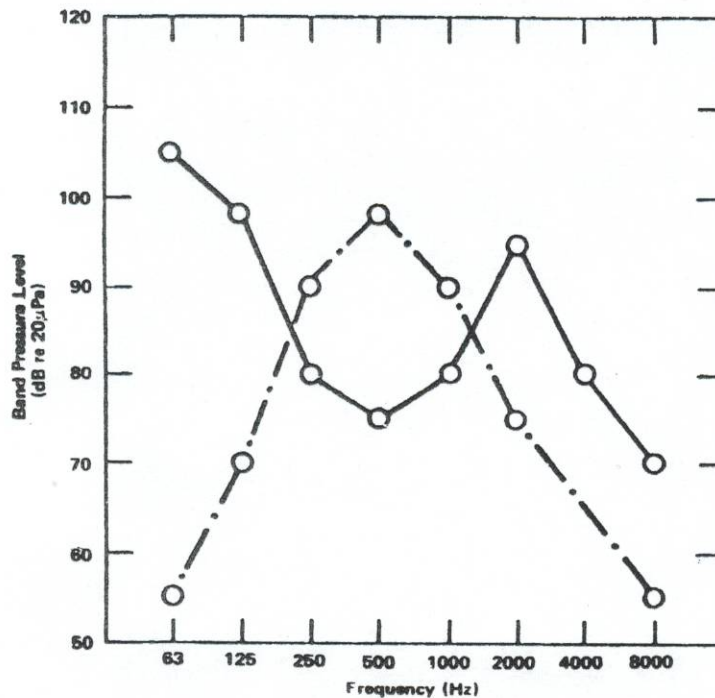

Figure 1-23. Two Noises, A-Weighted

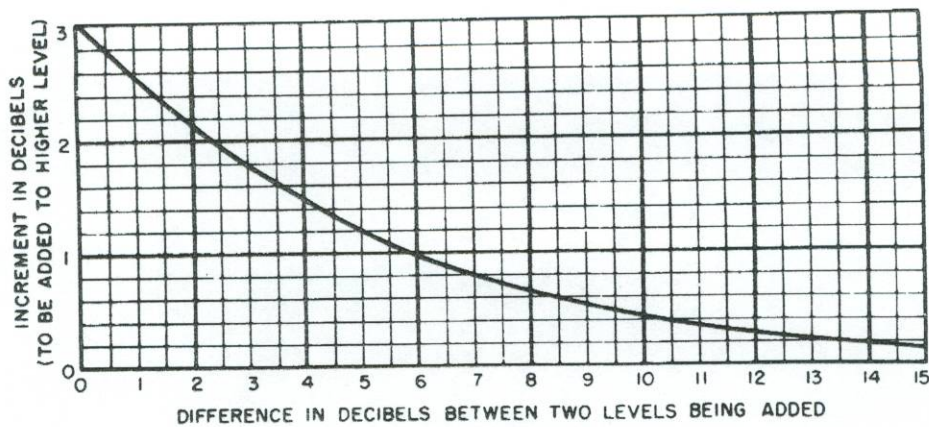

Figure 1-24. Decibel Manipulation Graph

Essentially, only the least sophisticated corrective action can be taken without octave-band data. The GR 1982 contains the preferred series of octave bands for acoustic measurements which cover the audible range in ten bands. The center frequencies of these bands are 31.5, 63, 125, 250, 500, 1000, 2000, 4000, 8000, and 16,000 Hz. The actual nominal frequency range of any one of these bands is 2-to-1; for example, the effective band for the 1000-Hz octave band extends from 707 to 1414 Hz.

1.8.5 Arithmetics of Decibels

A decibel is a logarithmic function which must be added and multiplied in a special manner. Figure 1-24 can be used to add decibels. The first step is to subtract the two levels to obtain the difference.

Locate this number along the horizontal axis. Move up the chart until you intersect the line, and then read the increment along the vertical axis. This increment is added to the larger decibel value to determine the new level. As can be seen, if two sources are 10 dB or more apart, the lower source adds very little to the overall noise level. For this reason most laws require the ambient level to be at least 10 dB below the level being measured. The following is an example of adding decibels. The readings listed below are the readings from various noise sources in an area. To find the overall level, proceed as follows:

- a. Arrange the numbers in descending order.
- b. Combine two at a time, then again two at a time, until only one number remains.

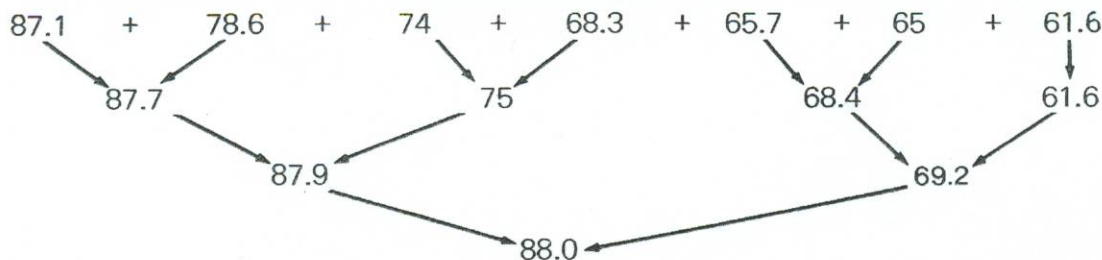

The first two numbers (87.1 and 78.6) are 8.5 apart. From Figure 1-24, it can be seen that the difference of 8.5 dB indicates that an increment of 0.6 dB should be added to the larger value. Continuing on, the final answer will be 88 dB. This is not significantly higher than the dominant level of 87.1, since all other levels are more than 10 dB apart.

c. Multiplying Decibels. If a room is filled with a number of noise sources of the same level, the dB levels can be multiplied to obtain the overall level. Table 1-5 shows that amount to be added to the level of the multiple sources.

Table 1-5

MULTIPLYING DECIBELS

Number of equal levels	2	3	4	5	6-7	8	9-10	N
Add dB	3 dB	5 dB	6 dB	7 dB	8 dB	9 dB	10 dB	10 Log N dB

Example: If 8 noise sources are present and the level of each is 80 dB, the resulting overall level is 89 dB. See Table 1-5.

1.8.6 Ear Protector Rating

Ear protectors will only be effective if they attenuate the frequency of the unwanted noise. Again the octave-band levels of the area must be known. As an example the noise level (OBA readings) in a wood-and-pulp processing plant is as follows:

Octave Band	125 Hz	250 Hz	500 Hz	1 kHz	2 kHz	4 kHz	8 kHz
Level	108	114	114	112	111	106	97

Use the chart in Figure 1-25 to determine if the hearing protectors are useful. The overall A-weighted level in this plant is 117 dBA. Using Figure 1-25 proceed as follows:

- a. Place the OBA readings on line 1.
- b. Subtract the A-weighting correction on line 2 and write results on line 3.
- c. Enter the ear protector standard deviation (times 2) on line 4.
- d. Add lines 3 and 4.
- e. Enter ear protector attenuation on line 6.
- f. Subtract line 6 from line 5 and enter on line 7.
- g. Reassemble the results on line 7 in descending order.
- h. Combine dB as described previously.

As can be seen from this example, the hearing protector selected did not solve the noise problem. This type of procedure must also be utilized to evaluate absorptive material.

NOTE

Figure 1-26, can be used as a sample for other applications.

1.8.7 Impulse or Impact Noise

A noise which repeats itself less often than once each second is considered to be of the impulse-type or impact noise. Due to the short duration of this noise, special detectors are sometimes used to measure this noise. Impulse-type noise can be produced by forging hammers, punch presses, stamping machines, etc. The GR 1982 contains detectors to measure this type of noise. The FAST and SLOW detectors are used to measure the energy in a varying noise field. The PEAK detector is used to measure the absolute peak of a sound. The IMPULSE detector is used to measure the energy in a short duration pulse.

Figure 1-25
EAR PROTECTOR RATING FORM

	- Frequency -						
	125 Hz	250 Hz	500 Hz	1 kHz	2 kHz	4 kHz	8 kHz
(1) Octave Band Level @ Worker's Ear (dB)	108	114	114	112	111	106	97
(2) "A" Weighting Correction (dB)	-16	-9	-3	0	+1	+1	-1
(3) Combine (1) and (2)	92	105	111	112	112	107	96
(4) Ear Protector Standard Deviation x 2 (dB)	3.8	3.8	6.3	8.6	7.4	10.8	108.2
(5) Add (3) and (4)	95.8	108.8	117.3	120.6	119.4	117.8	108.2
(6) Ear Protector Attenuation (dB)	15	22	33	44	43	48	32
(7) Subtract (6) from (5) For Corrected Level	80.8	86.8	84.3	76.6	76.4	69.8	76.2

Reassemble Corrected Levels (7) in descending Order	86.8	84.3	80.8	76.6	76.4	76.2	69.8
---	------	------	------	------	------	------	------

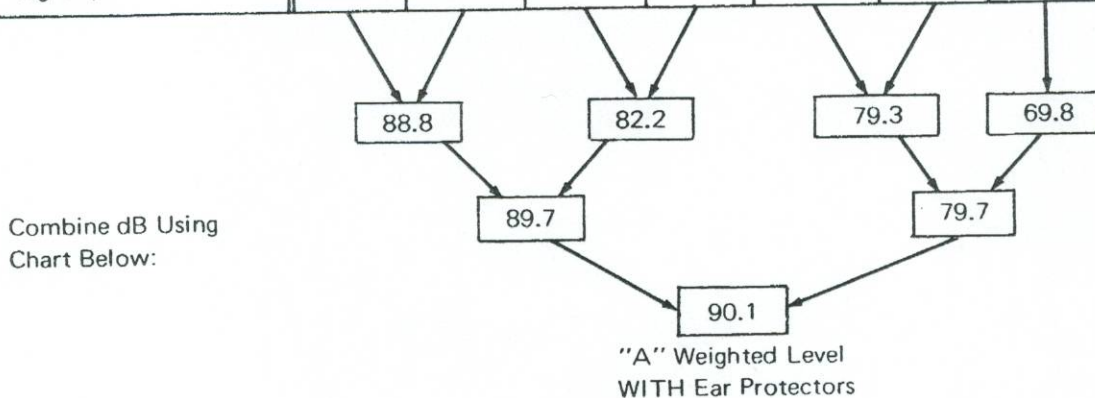

Combine dB Using Chart Below:

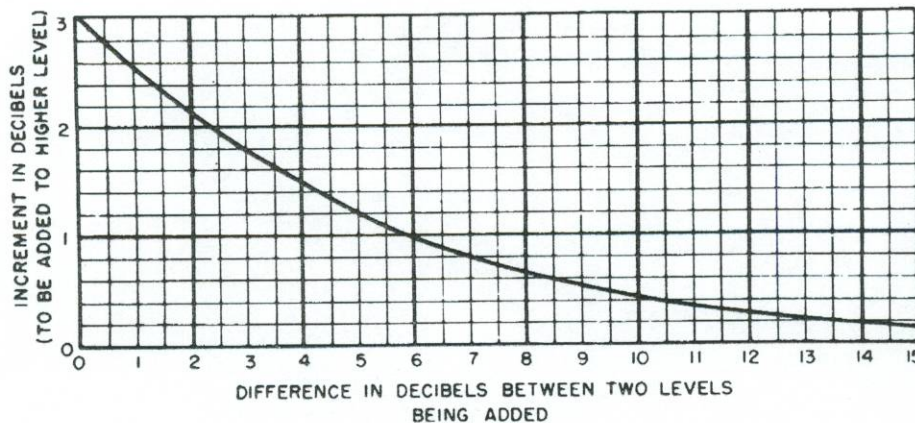

Figure 1-25. Use of Ear Protector Rating Form

Figure 1-26
EAR PROTECTOR RATING FORM

	- Frequency -						
	125 Hz	250 Hz	500 Hz	1 kHz	2 kHz	4 kHz	8 kHz
(1) Octave Band Level @ Worker's Ear (dB)							
(2) "A" Weighting Correction (dB)	-16	-9	-3	0	+1	+1	-1
(3) Combine (1) and (2)							
(4) Ear Protector Standard Deviation x 2 (dB)							
(5) Add (3) and (4)							
(6) Ear Protector Attenuation (dB)							
(7) Subtract (6) from (5) For Corrected Level							

Reassemble Corrected Levels (7) in descending Order							
---	--	--	--	--	--	--	--

Combine dB Using Chart Below:

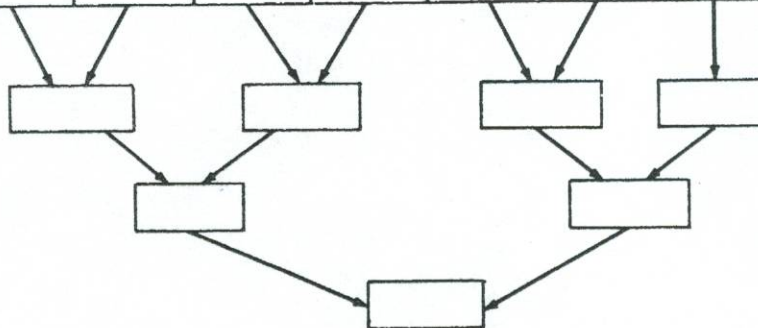

"A" Weighted Level
WITH Ear Protectors

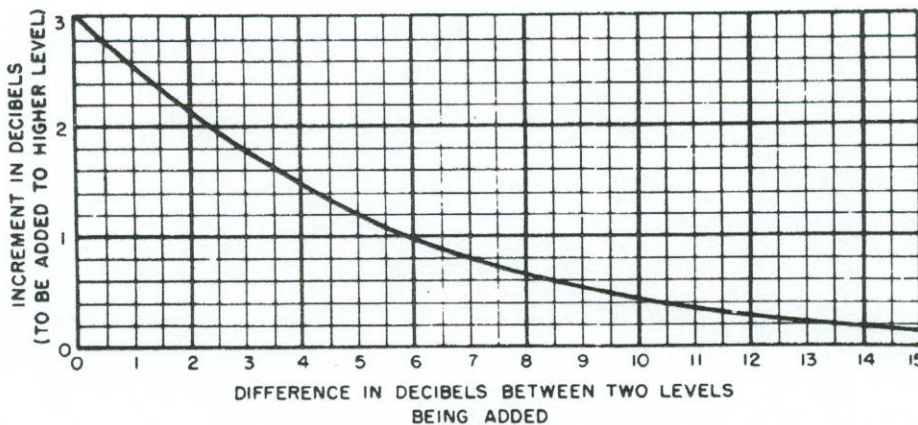

Figure 1-26. Ear Protector Rating Form

1.9 OPERATING PROCEDURES

Before making any noise measurements with the GR 1982 Sound Level Meter and Analyzer, perform the Initial Set-Up procedures as described in paragraph 1.6. The following operating procedures will be described.

1. General or Plant Noise Surveys
2. Measuring Noise in Octave Bands
3. Measuring Impulse-type or Impact Noise

1.9.1 General or Plant Noise Surveys

During the performance of any noise measurement procedure, observe the measurement considerations outlined in paragraph 1.7. To perform general noise measurements or plant noise surveys, proceed as follows:

- a. Perform the set-up procedures as described in paragraph 1.6.
- b. Position the 1982 Controls as follows:

DETECTOR	SLOW/FAST (as required)
dB RANGE	90-140
WEIGHTING	A
OCTAVE FILTER	WTG (Weighting)
DIGITAL DISPLAY	CONT
- c. With the left thumb, slide the power switch to the BAT position and hold. Observe that the meter pointer indicates within the BAT OK area and the display reads 888.8.
- d. If the requirements of step c are not met, refer to paragraph 1.6 for battery removal or charging information.
- e. Release the power switch to the ON position.
- f. Hold the 1982 away from the body at a convenient angle from the vertical to facilitate meter reading.

NOTE

Ensure that no part of the body interferes with the line-of-sight from the noise source to the microphone.

- g. When a random incidence microphone is used (1982-9700) stand with your side toward the noise source (Figure 1-13). Hold the instrument at arm's length and point it 70 degrees away from the noise source (Figure 1-14).
- h. When a perpendicular incidence microphone is used (1982-9710), stand with your left side toward the noise source. While holding instrument at arm's length (Figure 1-16), point the microphone directly at the noise source (Figure 1-17).
- i. If necessary, decrease the dB RANGE until an on-scale reading is observed around mid-scale.

WARNING

If a level of 115 dBA or higher is observed, put ear protectors on immediately to avoid a temporary hearing loss.

- j. If desired, the digital display can be frozen by pressing and holding the CAPTURE pushbutton on the left side of the 1982. The analog meter continues to track ambient noise.

NOTE

If at any time the OVERLOAD lamp at the upper left-hand corner of the meter face illuminates, switch to a higher range and disregard the indications that were observed during the time that the OVERLOAD lamp was illuminated.

- k. Document all meter indications and conditions under which the readings were taken.

NOTE

Slow detection response to a 500-ms tone burst, at 1000 Hz, is nominally 4.5 dB down from a reference-steady-state signal at the same level and frequency. Overshoot response to a signal suddenly applied and held constant, over the frequency range of 63 Hz to 8000 Hz, is nominally 0 dB.

1.9.2 Measuring Noise in Octave Bands

During the performance of any noise measurement procedure, observe the measurement considerations outlined in paragraph 1.7. To perform noise measurements in octave bands, proceed as follows:

- a. Perform the set-up procedure described in paragraph 1.6.
- b. Position the 1982 controls as follows:

DETECTOR	SLOW
dB RANGE	90-140
WEIGHTING	A
OCTAVE FILTER	WTG (Weighting)
DIGITAL DISPLAY	CONT

- c. With the left thumb, slide the power switch to BAT position and hold. Observe that meter pointer indicates within the BAT OK area and the display reads 888.8.
- d. If the requirements of step c are not met, refer to paragraph 1.6 for battery removal or charging procedures.
- e. Release the power switch to the ON position.
- f. Hold the 1982 away from the body at a convenient angle from vertical to facilitate meter reading.

NOTE

Ensure that no part of the body interferes with the line-of-sight from the noise source to the microphone.

- g. When a random-incidence microphone is used (1982-9700) stand with your side toward the noise source. Hold the instrument at arm's length and point it 70 degrees away from the noise source (Figure 1-13 and Figure 1-14).

- h. When a perpendicular-incidence microphone is used (1982-9710), stand with your side toward the noise source. While holding the instrument at arm's length, point the microphone directly at the noise source (Figure 1-16 and Figure 1-17).

- i. If necessary, decrease the dB RANGE until an on-scale reading is observed near mid-scale.

WARNING

If a level of 115 dBA or higher is observed, put ear protectors on immediately to avoid a temporary hearing loss.

j. If desired the digital display can be frozen by pressing and holding the CAPTURE button on the left side of the 1982. The analog meter continues to track ambient noise.

NOTE

If at any time the OVERLOAD lamp at the upper left hand corner of the meter face illuminates, switch to a higher range and disregard the indications that were observed during the time that the OVERLOAD lamp was illuminated.

k. Rotate the OCTAVE-FILTER switch away from the operator. Stop in each octave band, observe, and record level.

NOTE

The WEIGHTING switch is disabled when the OCTAVE-FILTER switch is not in the WTG position.

l. Document all meter indications and conditions under which the readings were taken.

1.9.3 Measuring Impulse or Impact Noise

During the performance of any noise measurement procedures observe the measurement considerations outlined in paragraph 1.7.

To perform measurements of impulse or impact noise proceed as follows:

a. Perform the set-up procedures described in paragraph 1.6.

b. Position the 1982 controls as follows:

DETECTOR	PEAK OR IMPULSE
dB RANGE	90-140
WEIGHTING	FLAT (peak), A (impulse)*
OCTAVE FILTER	WTG (Weighting)
DIGITAL DISPLAY	MAX

c. With the left thumb, slide power switch to BAT position and hold. Observe that meter pointer indicates within the BAT,OK area and that display reads 888.8.

d. If the requirements of step c are not met refer to paragraph 1.6 for battery removal or charging procedures.

e. Release the power switch to the ON position.

f. Hold the 1982 away from the body at a convenient angle from the vertical to facilitate meter readings.

NOTE

Ensure that no part of the body interferes with the line-of-sight from the noise source to the microphone.

g. When a random-incidence microphone is used (1982-9700) stand with your side toward the noise source. Hold the instrument at arm's length and point it 70 degrees away from the noise source (Figures 1-13 and 1-14).

* A-weighting is conventional for IMPULSE measurement and is specified by IEC 179A.

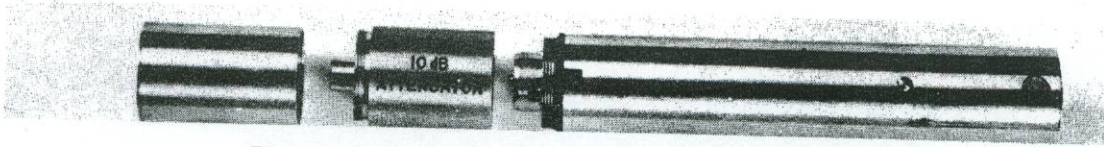

Figure 1-27. Microphone, Attenuator, and Preamplifier

- h. When a perpendicular-incidence microphone is used (1982-9710), stand with your left side toward the noise source. While holding the instrument at arm's length, point the microphone directly at the noise source (Figures 1-16 and 1-17).
- i. If necessary, increase the dB-RANGE control until an on-scale reading is observed near mid-scale.

WARNING

If a level of 115 dBA or higher is observed, put ear protectors on immediately to avoid a temporary hearing loss.

- j. If a peak level above 140 dB is observed, proceed as follows:
 1. Place the 1982 power switch to OFF.
 2. Place the 1982 flat on a bench, unscrew the microphone (Figure 1-27) from the preamplifier and place it gently on the bench. Thread the 1962-3210 10-dB attenuator, to preamplifier and thread the microphone to the attenuator. Figure 1-27 shows the microphone attenuator and preamplifier not connected.
 3. Calibrate the 1982 with the 10-dB attenuator in place, set it to read 104 dB.
 4. Proceed with the noise measurement as described above.

CAUTION

When the 10-dB attenuator is installed, the 1982 will indicate 10 dB less than the actual noise level at the microphone in all modes.

- k. To reset the peak or impulse detector before it decays completely, press and release the CAPTURE button.

NOTE

To retain the maximum indication that occurs during a measurement period, slide the DIGITAL DISPLAY switch to MAX.

1.9.4 Crest Factor Measurement

The noise most commonly found in industrial surroundings consists of many complex sounds. Many of these sounds have peak levels as high as 10 to 20 dB above the rms levels which are read with the slow response of the detector. It is often useful to know the difference between the rms and peak levels to calculate noise-dose exposure. This difference is known as crest factor.

- To measure the crest factor of a noise, proceed as follows:
- a. Measure the noise in accordance with paragraph 1.9.1, General or Plant Noise Surveys.
 - b. Record the indication in the SLOW detector response mode.
 - c. Position the DETECTOR switch to PEAK. Record the indication.
 - d. The difference between these two indications is the crest factor.

1.10 OPERATION WITH ACCESSORIES

The paragraphs in this section describe the operation of the 1982 Precision Sound Level Meter and Analyzer with the following accessories:

1. Tripod
2. Vibration Pickup
3. AC Recorder
4. DC Recorder
5. Audiometer Calibration Accessory Kit

1.10.1 Use of Remote Cable and Tripod

The GR 1560-9590 Tripod (Figure 1-15), a compact unit with elevating center-post, is used to support the microphone and preamplifier when they are used at the end of an extension cable. It can also be used to support the complete 1982. The tripod has a swivel head that permits 0 to 90-degree positioning in one direction and 0 to 30 degrees (for proper orientation of a microphone with flat-random-incidence response) in the other direction. The head has two concentric removable sleeves for mounting 1.0-inch diameter devices or 1/2-inch diameter preamplifiers. It also has a standard 1/4-20 screw and a locking nut for mounting the 1982. The friction in the swivel can be adjusted by removing the swivel from the center post of the tripod and adjusting the Allen-head screw in the base of the swivel.

To mount the 1982 microphone, preamplifier and cable on the tripod, proceed as follows:

- a. Remove the tripod from the carrying case.
- b. Position the tripod legs.
- c. Loosen the knurled nut on each leg and extend the legs to the desired length.
- d. Tighten the knurled nuts on the legs.
- e. On the top of the tripod, loosen the outside knurled collar and install 1/2-inch sleeve.
- f. Loosen the knurled screw on the top of the tripod and raise the vertical mast to the desired height. The tripod is now ready for use.
- g. Remove the preamplifier and microphone from the 1982 as follows:
 1. Hold the GR 1982 as shown in Figure 1-28.
 2. Use the calibration screwdriver to loosen the setscrew in the back of the unit by turning it 1 1/2 turns counterclockwise.

CAUTION

The setscrew is captive. It will not come out completely.
DO NOT force the screw against the stop. Forcing can cause damage to the threads and to the cover.

3. Hold the preamplifier with the thumb and forefinger (Figure 1-29), and pull the preamplifier with microphone attached away from the instrument and carefully place on bench.
- h. Install the preamplifier and microphone on an extension cable as follows:
 1. Hold the preamplifier and microphone in the right hand with the hole in the end of the preamplifier pointing upward (See Figure 1-30).
 2. Hold the plug end of the cable in the left hand and depress the clip as shown in Figure 1-30.

3. Carefully slide the preamplifier over the cable, ensuring that the hole in the preamplifier is aligned with ball on the clip.
 4. Rotate the cable gently to ensure that the ball protrudes fully through the hole in the preamplifier.
- i. Fit the cable into the 1982 as follows:
 1. Place the instrument face down on a bench.
 2. Hold the chrome end of the cable in the left hand with the hole in the end facing the operator.
 3. Align the hole in the cable connector with the hole in the back of the housing. This hole contains the locking setscrew.
 4. Carefully insert the cable connector into the top of the 1982 until it seats.
 5. Gently rotate the connector back and forth; it will index on a pin.
 6. Carefully push the connector into the socket until it seats.
 7. Using the calibration screwdriver, turn the setscrew in the back of the 1982 1 1/2-turns clockwise until the screw bottoms.
 - j. Slide the preamplifier into the 1/2-inch sleeve on the tripod.
 - k. Orient the microphone as described in paragraph 1.9.
 - l. The 1982 is now ready for use.

NOTE

Calibration correction not required when cable is used as described above.

1.10.2 Installation of Microphone and Preamplifier

If a remote cable is installed on the 1982, use the information contained in step a that follows; if not proceed to step c.

- a. Remove the preamplifier from the cable as follows:
 1. Use the thumbnail to depress the ball protruding through the hole in the bottom of the preamplifier.
 2. Hold the ball depressed and slide the preamplifier from the cable.
 3. Place the preamplifier in a safe location.
- b. Remove the cable from the instrument as follows:
 1. Hold the GR 1982 as shown in Figure 1-28.
 2. Using the calibration screwdriver loosen the setscrew in the back of the unit by turning it 1 1/2 turns counterclockwise.

CAUTION

**The setscrew is captive. It will not come out completely.
DO NOT force the screw against the stop. Forcing can cause
damage to the threads and to the cover.**

3. While holding the cable connector with the thumb and forefinger, pull the cable away from the instrument to release it from the socket.
4. Remove the cable from the instrument and store.
- c. Install the preamplifier and microphone in the 1982 housing as follows:
 1. Hold the preamplifier and microphone in the left hand with the hole in the end of the preamplifier facing the operator (see Figure 1-29.)

2. Place the instrument face down on the bench.
3. Align the hole in the end of the preamplifier with the hole in the back of the 1982 housing. This hole contains the locking setscrew.
4. Carefully insert the preamplifier into the top of the instrument until it seats.
5. Gently rotate the preamplifier back and forth; it will index on a pin.
6. Carefully push the preamplifier into the socket until it seats.
7. Using the calibration screwdriver, turn the setscrew in the back of the 1982 $1\frac{1}{2}$ turns clockwise until the screw bottoms.

1.10.3 Use of GR 1982 with Tripod

- a. Remove tripod from carrying case.
- b. Position the tripod legs.
- c. Loosen the knurled nut on each leg and extend the legs to the desired length.
- d. Tighten the knurled nuts on the legs.
- e. On the top of the tripod, loosen the outside knurled collar and remove the 1-inch sleeve (if not previously removed); also loosen the knurled collar on the 1/2-inch sleeve and remove it.
- f. Turn the 1/4-20 screw into the nut on the back of the 1982.
- g. When the screw is nearly tight, tighten the large knurled collar against the 1982.
- h. Raise the vertical mast on the tripod to the desired height.
- i. Orient the 1982 in accordance with paragraph 1.9.

1.10.4 Use With Vibration Integrator System

Noise exposure in an industrial environment may be caused by air-borne or by structure-borne sources. The structure-borne noise is caused by vibrating parts of machines. Some vibration is tolerable and necessary within a machine. However, if this vibration becomes excessive, machine wear and damage can result. When attempting to solve a noise problem it may be necessary to measure the level of vibration in terms of velocity, acceleration, and displacement in one part of the machine. When performing preventative maintenance on machines, it may be necessary to take periodic vibration measurements to determine whether maintenance is necessary.

When the GR 1982 is used with the 1933-9610 Vibration Integrator System, the system can be used for vibration measurement. To perform vibration measurements proceed as follows:

- a. Equipment Required:
 - 1982-9700/-9710 Sound Level Meter and Analyzer
 - *1933-9610 Vibration Integrator System
 - *1557-9702 Vibration Calibrator
- b. Place the GR 1982 flat on a bench.
- c. Carefully remove the microphone (See Figure 1-27). and set it aside.
- d. Thread the 1933-3030 Vibration Integrator Assembly connector (Figure 1-31). onto the 1982 preamplifier.
- e. Connect the Vibration Pickup (1560-9653) to the Vibration Integrator Assembly using the 8' cable supplied.

*Supplied with Instruction Manual

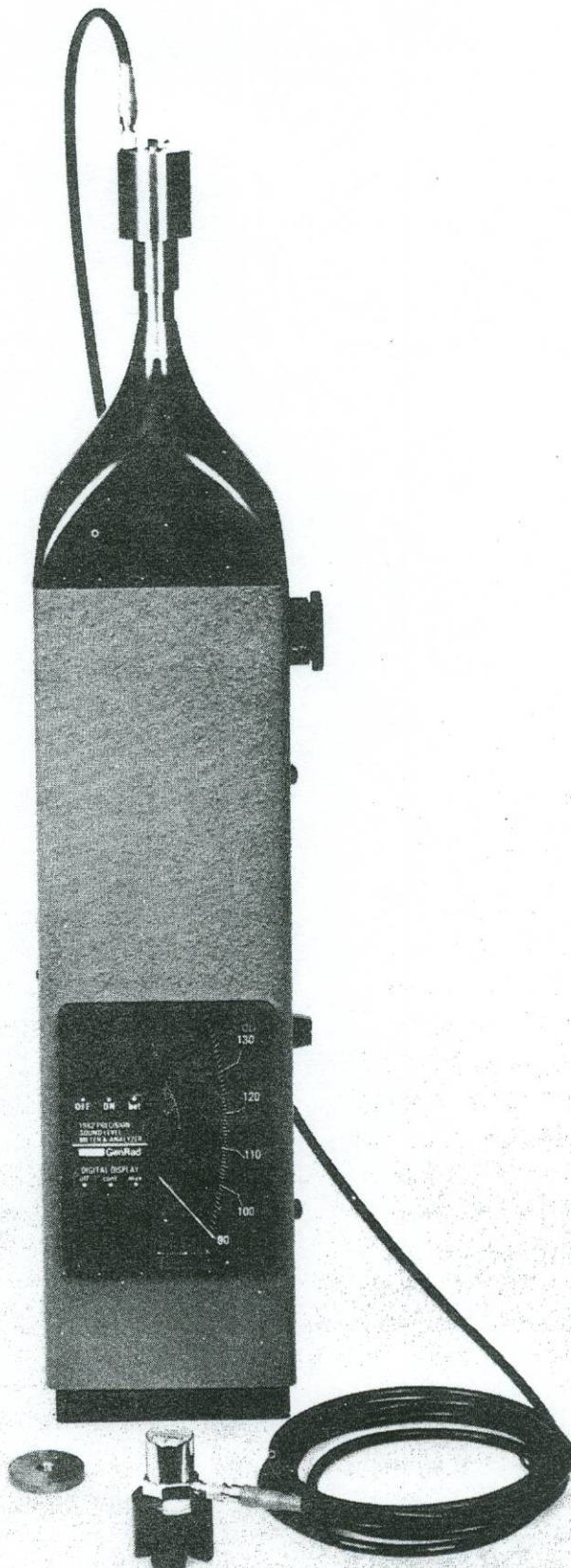
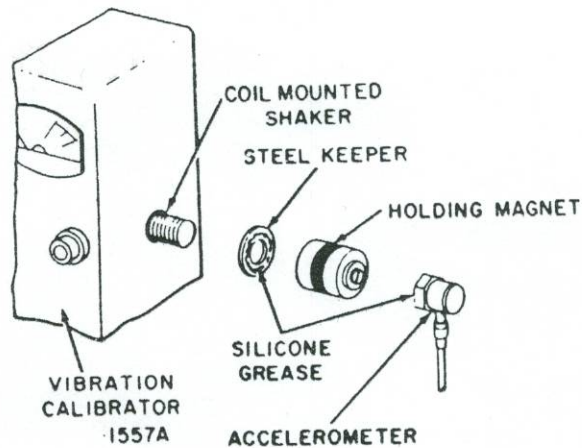

Figure 1-31. Vibration Integrator Used with 1982 SLM

Figure 1-32.
Mounting Pickup on Calibrator



f. Calibrate the system as follows:

1. Remove one of the 50-gram weights on the 1557 shaker.
2. Thread the magnet-keeper (1560-6641) to the 1557 shaker.
3. Mount the magnet and pickup on the keeper as shown in Figure 1-31.

4. Position the 1982 controls as follows:

POWER	ON
OCTAVE FILTER	WTG (Weighting)
RANGE	90-140
WEIGHTING	FLAT
DETECTOR	SLOW

and set Integrator to L_a .

5. Turn the 1557 on and allow a few seconds for the shaker in the calibrator to build up to amplitude.
6. Adjust the LEVEL control on the 1557 until the 1557 panel meter indicates 143.
7. The 1982 should read 109.8. Add 10 dB to this reading to obtain the acceleration level, L_a , in dB re 10^{-5} m/s². Use the 5-in. circular slide rule (supplied with 1933-9610 system) to convert 119.8 dB to a corresponding acceleration of $1 g = 9.8 \text{ m/s}^2 = 386 \text{ in/s}^2$.
8. If necessary adjust CAL control (on the 1982) if meter reading is above 110.3 or below 109.3.
9. Turn the integrator selector knob to L_v , the reading on the 1982 should be 83.9. This reading +40 (123.9) is the velocity level L_v in dB re 10^{-8} m/s for the shaker output of 1 g at 100 Hz (velocity = .015 m/s = 0.59 in./s.).
10. Turn the integrator selector to L_d , the reading should be 57.9. This reading +30 (87.9) is the displacement level, L_d , in dB re 10^{-9} for the shaker output of 1 g at 100 Hz (displacement = 0.0249 mm; 0.979 mils).

g. If the indications specified in step f are obtained, the 1982 Vibration Measurement System is ready for use.

h. Turn off the 1557 and remove the magnet keeper.

i. Refer to the paragraph 1.11 for interpretation of vibration measurements.

1.10.5 Use with GR 1935 Cassette Data Recorder

The 1935 can be used with the 1982 as a data recording system. In order to record data from the 1982, the AC OUT jack on the 1982 must be connected by a cable to

the CHAN A AUX IN jack on the right side of the 1935. This cable can be fabricated by using the two sub-miniature phone plugs (4270-1100) supplied with the 1982, or the 1560-9678 and 1560-9680 cables (available from GenRad) can be used. Playback is accomplished by connecting 1560-9679 cable (available as an accessory) between the A OUTPUT jack on the left side of the 1935 and the 1982 preamplifier input through the 1560-9609 dummy microphone and the 1962-3200, 10-dB attenuator.

1.10.5.1 Equipment Initial Set-up

Refer to paragraph 1.6 and perform the initial setup procedures for the 1982.

Set-up the 1935 for use as follows:

- a. For a complete description, refer to the instruction manual supplied with the 1935.
- b. Depress the PLAY button on the top of the 1935.
- c. Slide the BAT CHECK/CHAN B switch on the front of the 1935 to the BAT CHECK position.
- d. Observe that the CHANNEL B meter indicates to the right of the BAT CHECK mark.
- e. If the indication in step d is not obtained, proceed as follows:
 1. Press and release the STOP button.
 2. Slide the battery compartment cover (located at the rear of the 1935) off the instrument to expose the battery compartment.
 3. If batteries are installed in the instrument, remove them.
 4. Observe the proper polarity and install 5 alkaline C-cells in the battery compartment.
 5. Replace the battery compartment cover.
- f. Depress the STOP button far enough to cause the tape deck to open. Release the switch.
- g. Hold a tape cassette with the tape toward you and the side with the name plate up; insert the tape into the tape deck.
- h. Close the tape deck door.
- i. If necessary, press the REWIND button to rewind the tape.
- j. Press the tape counter reset button on top of the 1935 to reset the counter to zero.
- k. The 1935 is now ready for use.

1.10.5.2 Recording Data

Perform the initial setup procedures for the 1982 and 1935. To record data on the 1935, proceed as follows:

- a. Connect the AC OUT jack on the 1982 to the CHAN A AUX IN jack on the 1935.
- b. Position the 1982 Controls as follows:
 - POWER – ON
 - OCTAVE FILTER – WTG
 - WEIGHTING – FLAT
 - DETECTOR – SLOW
 - DIGITAL DISPLAY – CONT
 - dB RANGE – 70-120

- c. Position the 1935 controls as follows:
RANGE CODE CHANNEL B – ON
dB FULL SCALE – 120
FROM SLM-dB FULL SCALE – ON
PAUSE – Depressed
PLAY – Depressed
RECORD – Depressed
- d. Turn the dial on top of the 1562 to BAT TEST and hold for 3 seconds.
- e. Turn the 1562 dial to the 1 kHz position.
- f. While holding the 1982, carefully place the 1562 over the 1982 microphone.
- g. Adjust the CAL control on the 1982 with the calibration screwdriver to obtain an indication of 117 dB on the 1982.
- h. Adjust the CAL A control on the right side of the 1935 to obtain an indication of –10 on the CHANNEL A meter on the front of the 1935.
 - i. Reset the 1935 counter to zero.
 - j. Depress and release the 1935 PAUSE button.
 - k. Record the calibration tone for at least a count of 10 on the counter.
 - l. Depress and release the STOP button on the 1935.
- m. Recalibrate the 1982 to 114 dB. Remove the calibrator from the 1982.
- n. The system is now ready to record data.
- o. When the dB RANGE switch on the 1982 is set to a different range, the dB FULL SCALE switch on the 1935 should be set to the full scale value. This data will be recorded on Channel B of the 1935.

When recording data, ensure that the dynamic range of the 1935 is not exceeded as the full 50-dB scale cannot be used. Record on only the following portions of the 1982 scale:

1982 dB RANGE Setting	1935 Recording Range
30-80	39-80
50-100	61-100
70-120	79-120
90-140	99-140

1.10.5.3 Playback Data

To playback data into the 1982 which was recorded on the 1935, proceed as follows:

- a. Remove all cables between the 1982 and 1935 and rewind the tape in the 1935.
- b. Place the 1982 flat on a bench, unscrew the microphone (Figure 1-27) from the preamplifier and place it gently on the bench. Thread the 1962-3200, 10-dB attenuator, to preamplifier and thread the 1560-9609 dummy microphone to the attenuator.
- c. Connect the BNC end of the 1560-9679 cable to the dummy microphone. Connect the other end of the cable to the OUTPUT A jack on the left side of the 1935.
- d. *On the 1982:* Set POWER to ON, dB RANGE to 70-120, OCTAVE FILTER to WTG, WEIGHTING TO FLAT, and DETECTOR to SLOW.
- e. On the 1935, depress the PLAY button.

f. While the calibration tone is playing on the 1935, calibrate the 1982 to indicate 117 dB.

g. The 1982 will now be direct reading on the 70-120 dB scale from 79 to 120 dB.

On playback, the maximum record level on the 1935 will indicate 120 dB on the 1982. If the data was recorded with the 1982 set on the 90-140 dB range, on playback the 1982 indication of 120 dB will represent 140 dB. In this case, add 20 dB to 1982 reading. However, if the data was recorded with the 1982 set on the 50-100 dB range, a 120 dB indication on the 1982 during playback will represent 100 dB. In this situation, subtract 20 dB from the 1982 reading. A summary for all 1982 ranges is shown below.

1982 RANGE WHEN RECORDING	CORRECTION FACTOR FOR 1982 READING ON PLAYBACK
30-80 dB	-40 dB
50-100 dB	-20 dB
70-120 dB	DIRECT READING
90-140 dB	+20 dB

The data on the tape can now be analyzed in octave bands or A-weighting. With the 1935-9601 earphone (supplied with the 1935) connected to the 1982 AC OUT jack, the user can listen to the recorded data while it is being played back into the 1982.

1.10.6 Use with DC Recorder

The GR 1982 system is compatible with the GR 1985 Recorder. Refer to the GR 1985 instruction manual for operational details.

1.10.7 Use with Audiometer Calibration Accessory Kit

When used with the 1560-9619 Audiometer Calibration Accessory Kit, the 1982 can be used to check the acoustic output and attenuator linearity of an audiometer. The 1560-9619 includes a GR 1961 Electret-Condenser Microphone, an NBS 9A-type Earphone Coupler, a Calibration Stand Assembly, appropriate calibration data, and an instruction manual.

1.11 CONVERSION OF L_a , L_v , L_d TO VIBRATION UNITS

1.11.1 Calculator Units

At times the values of vibration quantities are required in either metric or English units. The Vibration Calculator, a 5-inch diameter circular slide rule supplied with the 1933-9610, makes the determination of vibration quantities from the SLM meter indication a rapid and easy task.

Theory—Section 2

2.1 GENERAL

As the name indicates, the 1982 is both a sound-level meter and a spectrum analyzer. It includes the sound-level weighting networks A, B, and C, an octave-band filter that is tunable to the 10 standard center frequencies from 31.5 Hz to 16 kHz and a flat or "all pass" characteristic that extends in frequency from 10 Hz to 20 kHz.

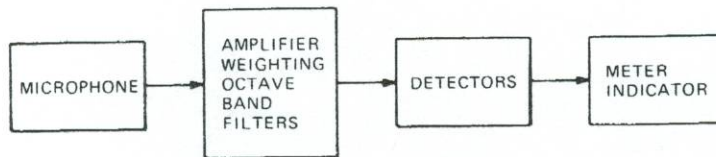

Figure 2-1. Elementary Sound-Level Meter, block diagram.

The 1982 comprises four main elements as shown in the block diagram, Figure 2-1. The microphone produces an electrical signal proportional to the applied sound pressure. This ac electrical signal is applied to an amplifier with frequency-selective networks that establish the "weighting" and octave-band filter characteristics. The amplification is adjustable in order to accommodate the four input sound pressure level ranges and to provide a precise means for calibration.

After amplification and filtering or weighting, the ac signal is applied to the detector where it is converted to a dc signal suitable for application to the indicator. The detector has closely controlled response-time characteristics to produce a dc signal proportional to the effective, or root mean square (RMS) value, or to the peak value of the filtered ac input signal. The detector output signal is applied to the indicator which may be a meter, digital display, or both as in the case of the 1982.

NOTE

The purpose of this section is to provide a comprehensive description of the circuits which comprise the 1982. This material should prove to be especially useful if any repair or troubleshooting is to be performed. It is recommended that the reader refer to the appropriate schematic diagram (Section 3) and to the block diagram (Figure 2-2) during this discussion.

2.2 MICROPHONE AND PREAMPLIFIER

The microphone is an electret-condenser microphone. Its basic design is similar to the conventional air-condenser microphone, but it has a permanently charged diaphragm and does not require a polarizing voltage. The electret-condenser microphone retains the advantages of conventional air-condenser microphones with high sensitivity, flat frequency response and wide dynamic range. In addition, it does not become noisy in a humid environment. The analyzer is supplied with either "flat random incidence"

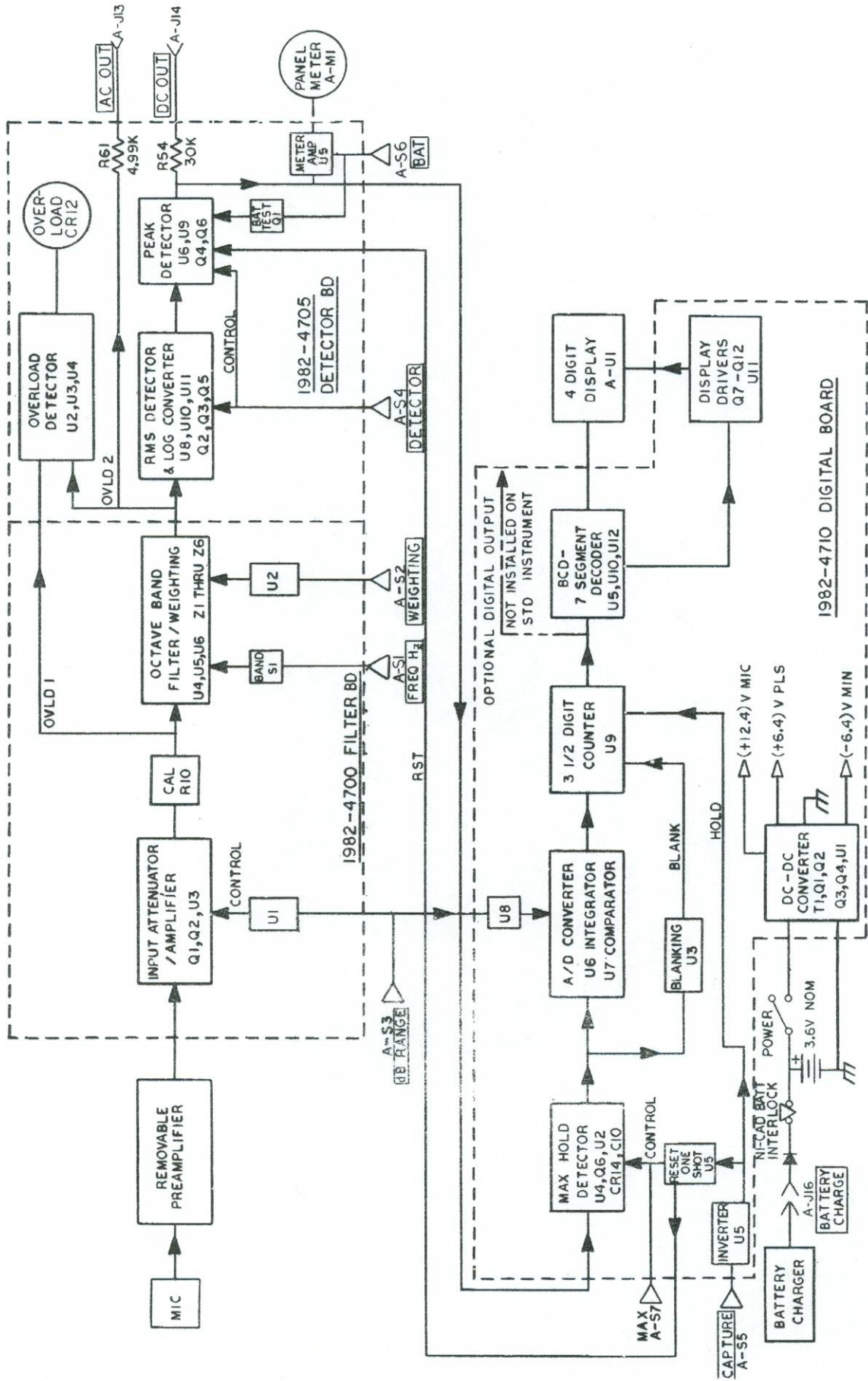

Figure 2-2. 1982, overall block diagram.

response microphone or "flat perpendicular incidence" response microphone. Typical frequency response and directional response characteristics are shown in Figures 1-18 and 1-19.

The preamplifier (1981-4000) is a wide-band, low-noise, unity-gain amplifier that features high input impedance and low output impedance. It serves as an interface between the high source impedance of the microphone and the input to the SLM. If the microphone is connected directly to a long cable (capacitive load) without a preamplifier, the long cable merely reduces the sensitivity of the microphone by forming a capacitive voltage attenuator. However, when the removable preamplifier and microphone are connected to the same end of the cable, the low output impedance of the preamplifier eliminates any losses due to the cable. Hence, there is no need for any cable correction factors.

2.3 INPUT AMPLIFIER/ATTENUATOR STAGE

Refer to Figure 3-10, Filter Board Schematic diagram. The input stage from the microphone and preamplifier has four levels of amplification or attenuation which provide the ranging function of the SLM. The input amplifier and electronic attenuator comprise U1, U3, Q1, Q2 and associated circuit components. A "high" level on one of the electronic switch control lines at J4, which are controlled by the dB RANGE switch, selects one of the 20-dB steps formed by the resistive attenuator, R1-R3. In the most sensitive range, 30-80 dB, the input amplifier provides an additional 20 dB of signal gain through R6. Q1 and Q2 form a low-noise, quasi-differential input to the output stage, U3.

CAL potentiometer, R10, provides continuous gain adjustment of the input stage to permit overall instrument calibration. This is necessary to compensate for sensitivity variations among different microphones.

2.4 OCTAVE-BAND FILTERS AND WEIGHTING NETWORK

Refer to Figure 3-10, Filter Board Schematic diagram. The signal from the input stage discussed in the previous paragraph drives the filter networks. The octave-band filters in the 1982 are resistance-capacitance-amplifier types (U4, U5, and U6) using the Sallen and Key configuration with three two-pole sections cascaded. U4 is a low-pass filter, U5 is a high-pass filter, and U6 is a band-pass filter. The octave-band center frequencies are selected by switching resistor values in the hybrid circuits, Z1 through Z6 with the octave-filter switch, S1.

The weighting networks A, B and C selected in the CCW position of S1, use much of the same circuitry as the octave-band filters. C12, C15, and R21 bypass the filters to provide the FLAT response. One of the three weightings, A, B, C, or FLAT is selected with an electronic switch, U2, by a "high" level on the appropriate control line at J2. These lines are controlled by the 4-position weighting switch.

Refer to Figure 2-3 for a simplified drawing of a typical filter network. Figure 2-4 shows the frequency response characteristics of the 1982 weighting networks. Figure 2-5 shows a normalized magnitude and phase response of a typical octave filter.

2.5 DETECTOR SYSTEM

Refer to Figure 3-12, Detector Board Schematic diagram. The circuits, located on the Detector Board, consist of an RMS detector, a peak detector in cascade, and

a separate overload peak detector. The RMS detector circuit U8, U10, U11, and Q5 provides a dc output voltage proportional to the logarithm of the RMS value of the ac input signal. The name of this ac input signal is FILTO and is derived from the output of the filter and weighting circuit. The dc output voltage from the detector at U8, pin 3 as noted on the schematic diagram, is proportional to the input, i.e., 6 mV/dB.

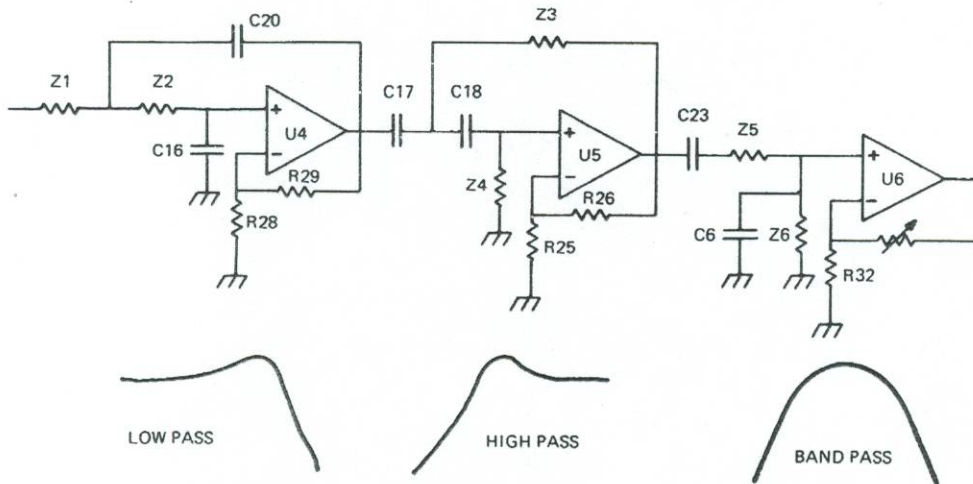

Figure 2-3. Typical filter network.

Curves exclude the possible acoustical effects of a microphone and are based on a 35-pF source impedance

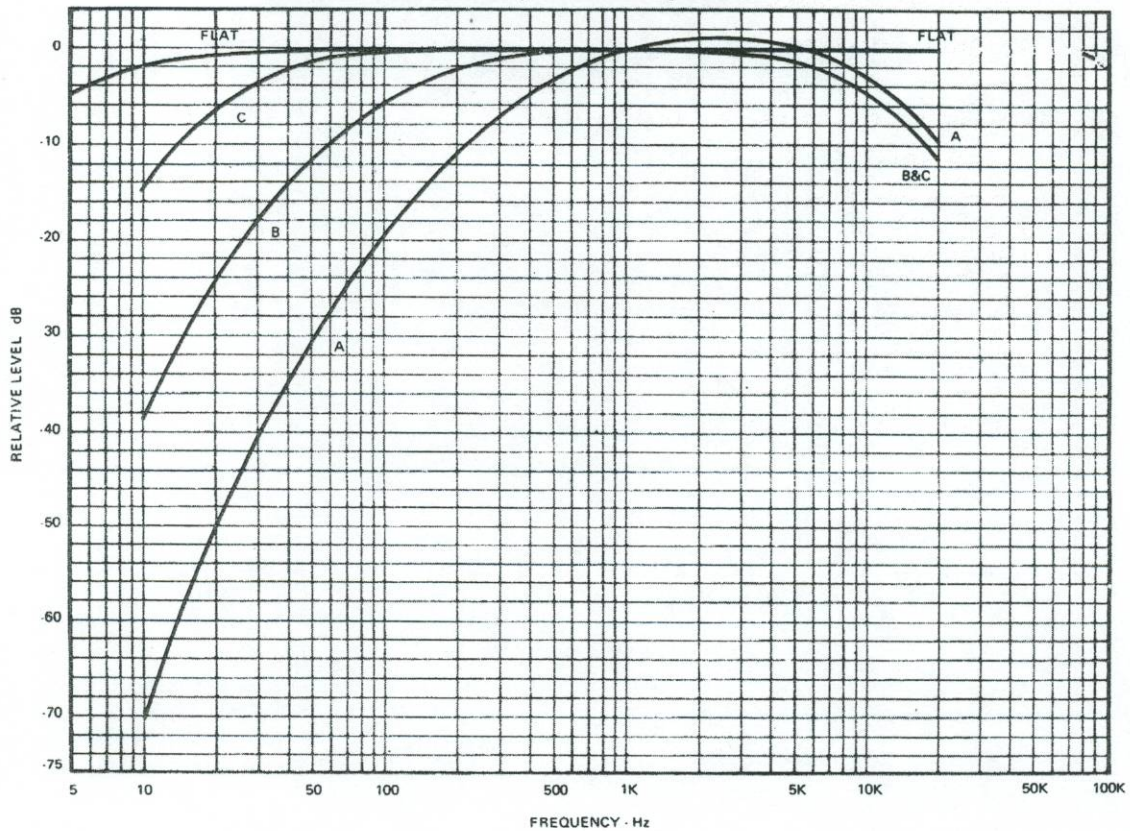
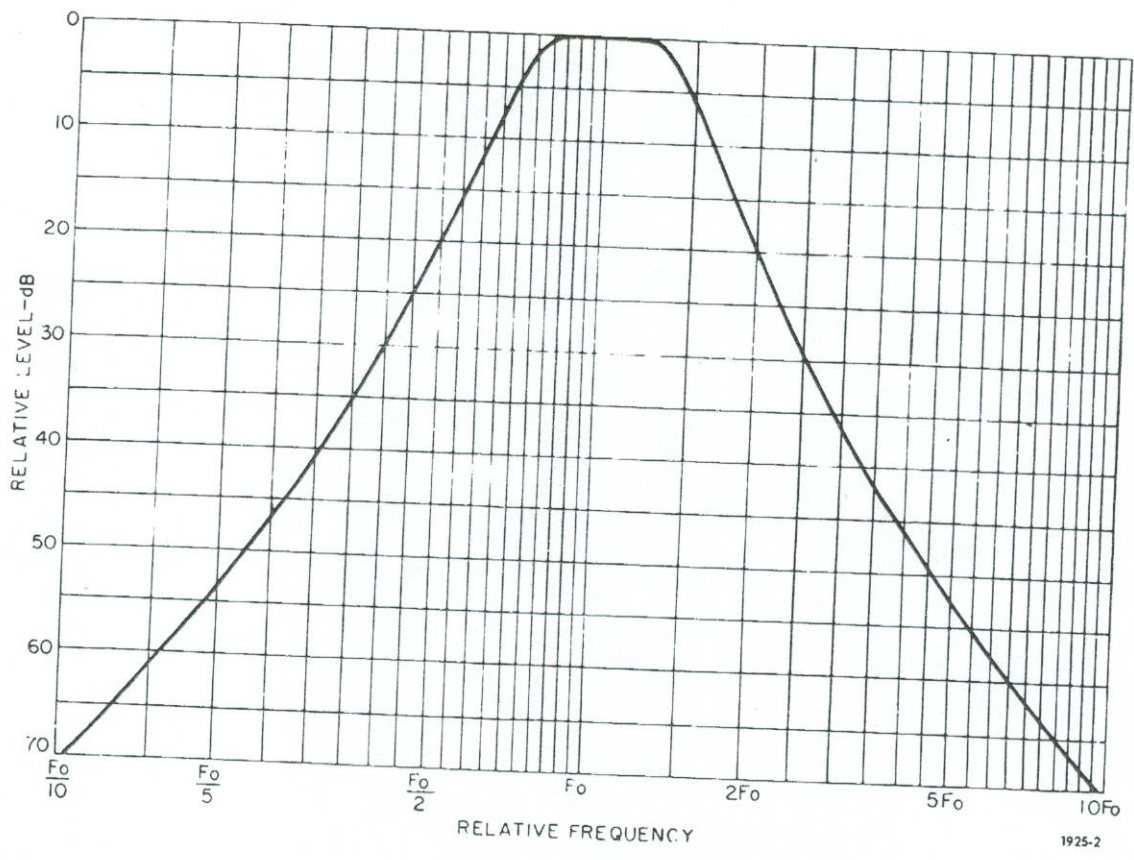
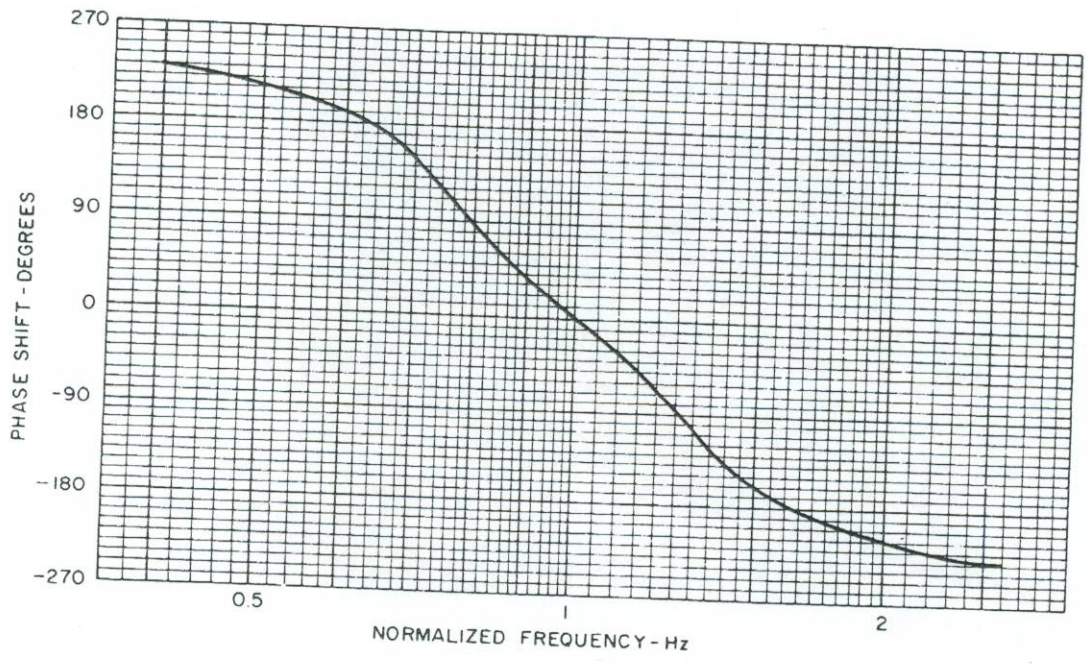

Figure 2-4. Frequency-response characteristics for 1982 SLM.



a. Normalized magnitude response.



b. Normalized phase response.

Figure 2-5. Normalized response of the 1982 octave-band filter.

NOTE

The electronic switch, U7, momentarily shorts the detector output to ground when the instrument is turned on to eliminate transients.

The detector response times for FAST and SLOW are established by C10 and C11 respectively. They are selected by a "high level on the appropriate control line at J6. For example, when the detector is set for a SLOW response, the SLOW control line is set "high" to turn on Q2 and to connect C11 to ground. In the FAST response mode, the FAST control line is set "high" to turn on Q3 and to connect C10 to ground. The PEAK detector comprises U9, U6, Q4, and Q6. In the FAST and SLOW modes, the PEAK detector function is bypassed, i.e., CR11 is shorted by the electronic switch, U7. In these modes the PEAK detector circuit serves as a dc amplifier only.

In the PEAK mode, the FAST and SLOW time constants in the RMS detector are bypassed, i.e., neither Q2 nor Q3 are enabled. However, the PEAK detector circuit is enabled, i.e., switch U7 is open and C9 charges to the absolute signal peak through CR11 (50 msec rise time). The decay time is established by the time constant of C9 and R32.

The PEAK detector is reset when the CAPTURE button is released. The release of this button also generates a positive RESET pulse at J7 (which originates on the Digital Board) and momentarily closes the bypass switch, U7 in the PEAK detector to discharge C9.

Both the RMS detector and PEAK detector are employed in the IMPULSE mode to provide an indication proportional to the peak of the short duration RMS value of the signal. In this case Q3 is turned on to employ C10 in the RMS detector circuit and U7 is open to employ CR11 in the PEAK detector circuit. Rise time for the IMPULSE detector function is 35 msec.

The detector output, DC OUT, drives the meter circuit and the digital display. The display circuit is located on the 1982-4710 Digital Board. The detector output also provides a 3-volt full-scale dc output voltage linear in dB at 60 mV/dB.

The overload PEAK detector circuit (U2, U3, and U4) monitors the ac signal at two points, before and after the filter and weighting networks. Signal OVLD1 monitors the input to the filter and weighting circuits and signal OVLD2 monitors the output. These two signals are full-wave rectified by U3 and U4. If either signal exceeds the overload threshold, the comparator (U2) lights the overload indicator CR12 to alert the operator of the overload condition.

2.6 METER AND BATTERY CHECK CIRCUIT

The meter circuit, comprised of U5 and the meter, AM1 is a current source configuration driven directly by the detector output, DC OUT. The meter circuit also indicates the charge on the battery. When the power switch S1, is pressed to the BAT position, the battery voltage is checked under full load and generally must be greater than 3.4 V. During BATTERY check, the output signal from the detector, DC OUT, is suppressed by Q1 with a "high" level on control line BATCK. The battery voltage, VBATCK, is applied to the meter circuit through R20, R52, and switch U7. R52 is adjusted to cause the meter to indicate at the low end of the BAT OK line at minimum voltage. The battery check function also performs a digital display lamp check, described in detail in Section 2.8.

2-6 THEORY

2.7 MAX HOLD DETECTOR

Refer to Figure 3-14, the Digital Board Schematic diagram. The circuitry located on the Digital Board consists of a Max Hold detector, A/D converter, display decoder and the instrument power supply.

The dc signal, representing sound level from the meter circuit is applied to the maximum hold circuit U4 and Q6. When the digital display is in the Continuous mode, electronic switch U2 is closed. The voltage on C10 simply tracks the operating level. When the circuit is in the maximum-hold mode, switch U2 is open. As the input voltage increases, the voltage on C10 increases beyond its peak. C10 is back biased when the input voltage starts dropping. The voltage on C10 decays negligibly due to leakage through U2, CR14, and Q6. The maximum-hold circuit voltage on C10 remains at the value attained when the input voltage peaked, thus it represents the maximum sound level. This voltage remains until a higher input occurs or until U2 closes and resets it.

Control voltage for the switch, U2, is obtained from the "Maximum-hold reset one-shot" circuit of U5. In the Continuous mode, display switch A-S7 jams the control line to U2 "high" through CR13 and U2 remains closed. The control line is held low in the MAX mode and only goes high to reset the circuit when the CAPTURE button is depressed. When this button is released, a one-shot pulse of about 5 msec is produced by U5. This reset pulse momentarily closes U2 and establishes the voltage on C10 at the present input level. When the pulse terminates, the circuit resumes its maximum-hold operation.

2.8 PRINCIPLES OF A/D CONVERTER

Refer to simplified diagrams, Figures 2-6 and 2-7. The analog-to-digital converter uses a dual-slope integration technique. This scheme is widely accepted because of its simplicity and accuracy. The basic configuration and operation are shown in the accompanying figures. Capacitor C22 is successively charged and discharged, with an "unknown" voltage (the analog input) and a reference, respectively. The charge time is controlled and the discharge period measured by the timer. The following expressions describe this process and define its result:

$$Q_C = I_U t_c; I_U = \frac{E_U}{R_{20}} \quad ; \quad Q_C = \frac{E_U t_c}{R_{20}}$$

$$Q_D = I_{ref} t_d; I_{ref} = \frac{E_{ref}}{R_{20}} \quad ; \quad Q_D = \frac{E_{ref}}{R_{20}} t_d$$

$$Q_C = Q_D; \frac{E_U t_c}{R_{20}} = \frac{E_{ref} t_d}{R_{20}}$$

$$\frac{t_d}{t_c} = \frac{E_U}{E_{ref}}$$

Where: Q_C = charge placed on C22 by "unknown" current (input), Voltage (R20)

Q_D = charge removed from C22 by reference current (Ref Voltage/R20)

I_U = charge current, from "unknown"

I_{ref} = discharge current, from reference

t_c = charge time, fixed by timer

t_d = discharge time, proportional to unknown, measured by timer.

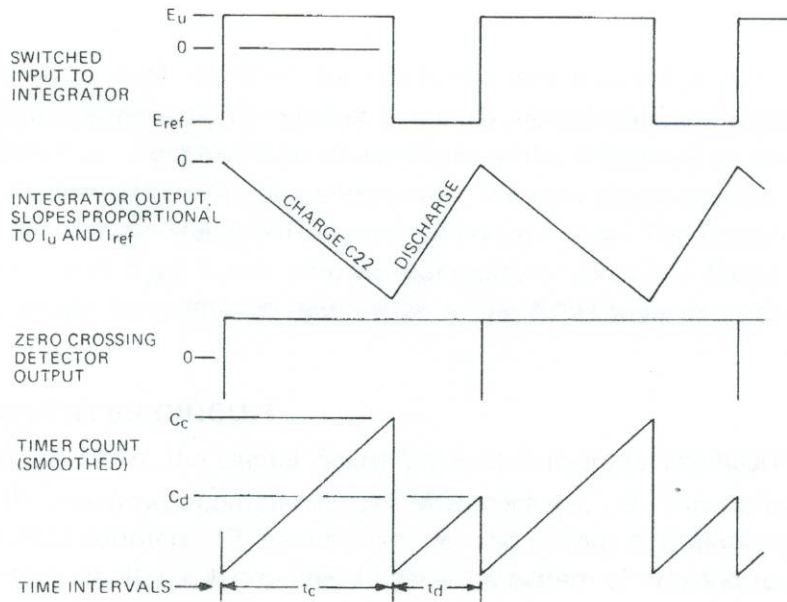

Figure 2-6. Elementary waveform and timing diagram for dual-slope A/D converter.

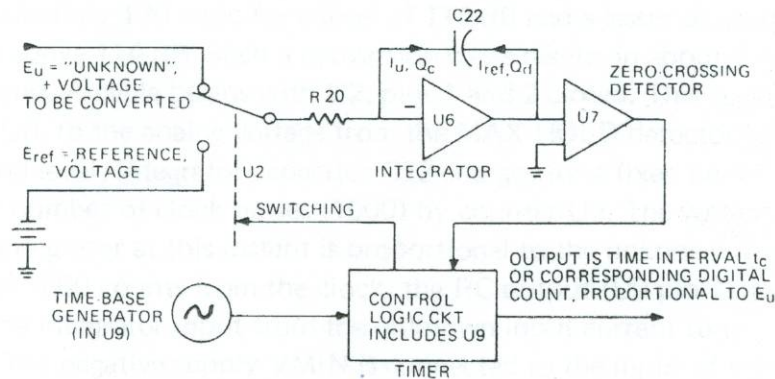

Figure 2-7. Dual-slope A/D converter, elementary block diagram.

It can be seen that the ratio of the discharge time to charge time equals the ratio of the "unknown" voltage to the reference voltage. If the time intervals t_c and t_d are known in arbitrary units equal to the period of the timer's clock, then the proportionality becomes:

$$\frac{C_d}{C_c} = \frac{E_U}{E_{ref}} ; C_d = \frac{E_U C_c}{E_{ref}}$$

Where: C_d = count accumulated during discharge time t_d
 C_c = count accumulated during charge time t_c .

The value of C_c is chosen to give the desired resolution and full-scale value. It is fixed by the timer design. For the 1982, $C_c = 1,000$, so:

$$C_d = \frac{E_U}{E_{ref}} \times 1,000.$$

2-8 THEORY

A-U1. The display is energized one digit at a time so rapidly that there is no visible flicker. To light a particular segment in a given digit, the appropriate segment line (A-U1, inputs a thru g) must be made positive or "high" while the appropriate digit line (A-U1, C1 thru C4) is set "low". The appropriate digit line is set "low" through the action of the corresponding drive transistor (Q9 thru Q11).

The 1982 display requires one decimal point. The decimal point line of the 4-digit display A-U1, is driven "high" through Q12 when the second least significant digit is scanned. Even though the display may be blanked, this decimal point is lit, hence, it also serves as a pilot light for this display. Note that there are the two additional control lines \overline{LT} and $\overline{B1}$ to the decoder U12. Line \overline{LT} is set "low" through gates U5, pin 6 and U10, pin 2, when the power switch is moved to the BAT position. This causes all segments to light and results in the display of "888.8". The control for line $\overline{B1}$ is the blanking circuit, U3, shown on the upper left of the schematic diagram, Figure 3-14. The output of U3, BLNK goes "high" when the input signal drops to approximately 6 dB below bottom scale. The "high" on this line, gated through U11, pin 10 and U10, pin 6 to the $\overline{B1}$ control of decoder U12, will shut off the display.

2.10 POWER SUPPLY

Refer to Figure 3-14, the Digital Board Schematic diagram. The power supply uses Q1, Q2 and the transformer (T1) connected as a self-excited dc-dc converter. Its frequency of oscillation is approximately 80 kHz. Positive feedback to the base of Q1 and Q2 is taken from the secondary of T1. CR1, CR2, CR3, and CR4 provide full-wave rectified positive and negative dc voltages of ± 6.4 Vdc. The negative output is regulated directly; the positive supply voltage tracks the regulated negative voltage (since both voltages are derived from the transformer). A voltage doubler comprised of CR7 and CR8 provides a 12.4 Vdc supply to power the external preamplifier.

A constant current is established through Q5, a two-terminal device comprising a FET with gate tied to source. Q5 supplies a constant current equal to its I_{DSS} . This current is divided between U1 and CR9, a 6.4 V temperature-compensated Zener diode. For the sake of simplicity, assume that the negative supply voltage changes erroneously in a positive direction. The change will couple to Q4 through CR9 and U1. Q4 will draw more current through the series regulator Q3, thus increasing the drive level to Q1 and Q2. The supply output voltage is raised correcting the original error.

The circuits on the Filter Board, Figure 3-10, the Detector Board, Figure 3-12, and the analog circuits on the Digital Board, Figure 3-14, are powered directly from the power supply voltages, VPLS and VMIN. However, the digital circuits on the Digital Board, with the exception of the positive supply for U10, U12, Q7, and Q12 are driven from additionally filtered supplies, VPLSA and VMINA. The digital power supply filters are comprised of R61, R33, C16, C18, C19, and C20 on the Digital Board. U10, U12, Q6 and Q7 which were identified in the preceding section as part of the display driver circuitry, are powered directly from the battery VBATA because of the relatively high currents required by the display. When the digital display is shut off the display slide switch, A-S7, VBATA is also shut off, however, VPLSA and VMINA continue to be applied to the balance of the digital circuits. The clock in U9 is inhibited by a "low" level at pin 5 from the comparator U7, to reduce circuit noise and to save power. The comparator output is "low" when U7's positive power, VPLSB, is out off by the action of Display switch A-S7.

2-10 THEORY